



Technical Report

## A Framework for Radio Frequency Spectrum Measurement and Analysis

V. Rory Petty

ITTC-FY2008-TR-34330-02

March 2008

Project Sponsor:  
National Science Foundation  
Computer and Information  
Science and Engineering Directorate

## **Abstract**

Inefficient spectrum allocation and the burgeoning problem of spectrum scarcity have prompted an examination of how the radio frequency spectrum is utilized. The radio frequency spectrum is an important national resource that impacts the economy, national security and daily life. Various studies have taken up the task of re-thinking spectrum licensing and allocation with the intent of encouraging the development of spectrally agile and efficient technologies. Thus, the ability to accurately measure spectrum usage directly effects the creation and modification of public policy.

This thesis presents a framework designed to measure, characterize and model spectrum utilization. While individual organizations have performed spectrum measurements, a framework does not currently exist to coordinate spectrum data sharing or distributed measurement campaigns. This thesis discusses the development of a shared database schema that can accommodate large scale and long term spectrum measurement campaigns. The implementation of this schema also allows multiple researchers to share experiment configurations and data. The development of a software program that can automate spectrum measurements is covered, along with its ability to facilitate the sharing of those measurements with a central archive. The creation of a spectrum measurement repository is discussed as well. Research is presented regarding the use of a low cost, mobile software-defined radio platform as a spectrum data collection device. Finally, various case studies are presented demonstrating how the technologies and techniques produced during the creation of this thesis can be used to analyze spectrum measurement data.

## **Acknowledgements**

I would like to first thank my adviser, Dr. Gary J. Minden, for the support and guidance he has provided me during my work as a Graduate Research Assistant. Dr. Minden's broad knowledge of engineering, science and other disciplines is as rich and varied as anyone I have ever known and working for him has proved to be consistently challenging and exciting. Early in my undergraduate studies, I became interested in participating in engineering research. Despite having little experience at the time, Dr. Minden hired me to work on one of his research projects and I have been working for him in various capacities for the last five years. I have had the privilege of working in a variety of computer engineering fields including software-defined radios, embedded systems, reconfigurable hardware, communications systems, software engineering and hardware design. Dr. Minden's knowledge of systems engineering, covering both the hardware and software domains, has helped me to develop real world research and development skills that I doubt I would have acquired through classes alone. I thank him for his encouragement, advice and friendship.

I also owe a debt of gratitude to my other thesis committee members, Dr. Joseph Evans and Dr. Alex Wyglinski. Dr. Evans has provided valuable insights into the research community, especially in the areas of communications and networking. He has also proved to be an effective sounding board for ideas and a thoughtful collaborator on various research papers. Dr. Wyglinski has also been a great collaborator and mentor. He enthusiastically encouraged the entire lab to increase the quality of their research and the publication of said research at conferences and in journals. Without his insights, comments and comprehensive editing, we would have never been able to publish multiple conference and journal papers. In conclusion, I would not hesitate to count both of these individuals as friends.

Two individuals who are every bit as important as the members of my thesis committee are the senior design engineers for our laboratory, Leon Searl and Dan DePardo. Their experience, patience and technical ability continue to amaze me. It goes without saying that a large majority of our research would not be possible without their work. Their insights and guidance have shaped this research work from the very start. I cannot express how grateful I am for their assistance and friendship.

I would like to thank my colleagues Ted Weidling and Jordan Guffey for their assistance and encouragement in the variety of research projects that we have worked on together. It is a rare privilege to work everyday with friends and I have enjoyed every moment. Our travels throughout Europe, including our trip to the DySpan conference in Ireland, have provided some of the most memorable experiences of my life thus far. I want to also extend thanks to my colleagues in Room 245, including Tim Newman, Dinesh Datla, and Rakesh Rajbanshi, amongst others. Finally, I want to thank colleagues that have moved on to other endeavors, including Ryan Reed, Brian Cordill, Preeti Krishnan and Levi Pierce. All of you have provided advice, support and assistance in some manner and you have all made the “MinLab” a great place to work.

Finally, I would like to thank my father Russ, my mother Leslie and my brothers Taylor and Garrett for their support and encouragement during my graduate studies, especially during the writing of my thesis. It goes without saying that this same support was provided by my entire extended family and all of my friends. Even though I may not always express this sentiment, I hope you all know how much I value your support and I thank you for it.

This work has been supported by the National Science Foundation under grants ANI-0230786 and ANI-0335272.

## Table of Contents

Title Page .....	i
Acceptance Page .....	i
Abstract .....	ii
Acknowledgements .....	iii
Table of Contents .....	vi
List of Figures .....	viii
List of Tables .....	xi
List of Terms and Abbreviations .....	xii
Chapter 1 – Introduction .....	1
1.1 What is spectrum? .....	3
1.2 Research Motivation .....	5
1.3 The National Radio Network Research Testbed (NRNRT) project .....	10
1.4 Research Objectives and Contributions .....	11
1.5 Thesis Outline .....	12
Chapter 2 – Background .....	15
2.1 Regulatory History .....	15
2.2 Spectrum Scarcity .....	16
2.3 Dynamic Spectrum Access .....	18
2.4 Spectrum Measurement .....	22
2.4.1 Distributed spectrum measurements .....	27
2.5 Spectrum Sensing / Signal Detection .....	28
2.6 Cognitive Radios .....	31
2.6.1 Background .....	31
2.6.2 KUAR .....	33
2.7 Summary .....	38
Chapter 3 – Proposed Research and Designs .....	39
3.1 Design Requirements and Specifications .....	39
3.2 Kansas University Spectrum Utilization Framework .....	40
3.2.1 Spectrum Measurement Workflow .....	41
3.3 Spectrum Miner design .....	42
3.4 Spectrum Repository design .....	44
3.5 Database design .....	45
3.5.1 Database tables .....	46
3.5.1.1 Database usage workflow .....	46
3.5.1.2 Relational structure of Synchronized and Atomic tables .....	49
3.5.1.3 Synchronized tables .....	50
3.5.1.3.1 Sweep Set Name table .....	51
3.5.1.3.2 Sweep Set Definition table .....	51
3.5.1.3.3 Organization table .....	53
3.5.1.3.4 Analyzer Settings table .....	53
3.5.1.3.5 Antenna table .....	57

3.5.1.3.6	Sweep Set Instance table.....	59
3.5.1.4	Atomic tables .....	61
3.5.1.4.1	Measurement-<GUID> tables.....	61
3.5.1.4.2	Sweep-<GUID> tables.....	62
3.6	Database Archival Import / Export Formats.....	63
3.6.1	Spectrum Miner Archive Format.....	64
3.6.2	General Export Format .....	64
3.7	Database Storage Requirements .....	64
3.7.1	Disk space estimation .....	65
Chapter 4	– Implementation.....	67
4.1	Spectrum Miner .....	67
4.1.1	Measurement / Data Collection .....	68
4.1.1.1	HP 8594E spectrum analyzer.....	70
4.1.1.2	IFR 2398 spectrum analyzer.....	71
4.1.1.3	KUAR spectrum analyzer radio configuration .....	71
4.1.2	Program Layout and Usage.....	74
4.1.2.1	Define antenna options .....	75
4.1.2.2	Define Analyzer Settings .....	77
4.1.2.3	Creating a Sweep Set .....	79
4.1.2.4	Measurement options.....	80
4.1.2.5	Taking measurements .....	81
4.1.2.6	Spectrum Miner program settings.....	81
4.1.2.7	Data Import and Export .....	82
4.1.3	Data Verification.....	84
4.2	Spectrum Repository.....	85
Chapter 5	– Measurements.....	91
5.1	Calibration and Verification .....	92
5.2	Case Studies .....	93
5.2.1	Case Study 1 – FM band measurement and development of signal classification algorithm.....	93
5.2.1.1	Development of signal classification algorithm .....	95
5.2.1.2	Performance Metric for the Classification Algorithm .....	103
5.2.2	Case Study 2 – Analog and Digital Television Measurements at the WIBW television tower .....	104
5.2.2.1	Background.....	104
5.2.2.2	Field Measurements.....	106
5.2.3	Case Study 3 - KUAR laboratory measurements .....	110
Chapter 6	– Conclusion.....	119
6.1	Future Work .....	119
References	.....	121
Appendix A	– Matlab workspace import.....	127
Appendix B	– KUAR spectrum measurement calibration.....	128

## List of Figures

Figure 1 – The Electrospace represented in its three most basic dimensions [5] .....	3
Figure 2 – Inverse square law .....	4
Figure 3 – FCC spectrum allocation chart .....	6
Figure 4 – White Space as a share of TV band in sample U.S. media markets [7] .....	7
Figure 5 – Example of whitespace and unlicensed device operation in DTV band [18] .....	20
Figure 6 – NTIA mobile Radio Spectrum Measurement System (RSMS).....	24
Figure 7 – KUAR Radio .....	34
Figure 8 – KUAR System Diagram .....	35
Figure 9 – Kansas University Spectrum Utilization Framework (KUSUF) data flow	40
Figure 10 – Spectrum measurement workflow for the KUSUF .....	41
Figure 11 - Distributed layout of the software architecture .....	43
Figure 12 – Relational structure of synchronized and atomic tables in the database [53].....	49
Figure 13 – Resolution bandwidth requirements for resolving small signals on an HP 8590 spectrum analyzer (copyright HP / Agilent Labs) [64].....	56
Figure 14 – Discrete measurements of spectrum bound by bandwidth resolution and bin width .....	69
Figure 15 – Multiple analyzer sweeps required to cover a band; unnecessary samples discarded .....	70
Figure 16 – Total, effective and usable KUAR RF baseband bandwidth.....	72
Figure 17 – Spectrum Miner to KUAR control and data flow .....	74
Figure 18 – Spectrum Miner program .....	75
Figure 19 - Antenna Options window.....	76
Figure 20 - Analyzer Settings window .....	78
Figure 21 - Sweep Set Definition window.....	80
Figure 22 - Measurement Gathering Dialog .....	80
Figure 23 - Count down dialog .....	81
Figure 24 – Spectrum Miner Settings Window .....	82
Figure 25 – Manage Data window.....	82
Figure 26 - Manage Data Window with filtering options.....	83
Figure 27 - Example CSV format file in Microsoft Excel.....	83
Figure 28 - Export Dialog.....	84
Figure 29 – Spectrum Repository integration with PHPNuke content management system .....	86
Figure 30 – Remote client interface methods with the Spectrum Repository .....	87
Figure 31 – Spectrum Repository search and filtering interface .....	88
Figure 32 – Spectrum Repository search filtering by organization and date / time ...	89
Figure 33 – Official Times Microwave LMR-600 plot of power loss [67].....	93
Figure 34 – Waterfall plot of 90-93 MHz (FM band) over 24 hours in Lawrence, KS .....	94



Figure 35 – Waterfall plot of power (dBm) values over 40 minutes of FM station KJHK 90.7 in Lawrence, KS .....	95
Figure 36 – CDF plot of the measurements collected over 24 hours from the 90-93 MHz band in Lawrence, KS.....	98
Figure 37 – Normal distribution over 8 iterations of the ROSHT algorithm for a 99% confidence interval.....	100
Figure 38 - Iterations of the Hypothesis Testing algorithm for 99% confidence of signal.....	101
Figure 39 - Comparison of duty cycle for varying confidence interval values (24 hr. measurement of the FM band).....	102
Figure 40 – Duty cycle plot of detected FM stations using the ROSHT algorithm..	102
Figure 41 – Field measurement equipment.....	107
Figure 42 – Map of the measurement locations.....	108
Figure 43 – Averaged power measurements of analog TV spectrum for Channel 13 (210-216 MHz) measured at varying distances from the transmitter .....	109
Figure 44 – Averaged power measurements of digital TV spectrum for Channel 44 (650 – 656 MHz) measured at varying distances from the transmitter.....	109
Figure 45 – Spectrum Miner re-ordering of frequency domain samples from KUAR FFT.....	111
Figure 46 – HP spectrum analyzer and KUAR calibration setup .....	114
Figure 47 - KUAR measured relative power values of a tone at 5.31 GHz for varying signal generator output power transmitted over the air in the laboratory .....	115
Figure 48 - KUAR measured power values in dB of a tone at 5.31 GHz for varying signal generator output power transmitted over the air in the laboratory .....	116
Figure 49 - KUAR measured power values (dB) with a correction factor of a tone at 5.31 GHz for varying signal generator output power transmitted over the air in the laboratory .....	116
Figure 50 – Relationship between KUAR and SA measured power for varying SG output power .....	117
Figure 51 – KUAR measured relative power values for a -20 dBm tone at 5.31 GHz transmitted over the air in the laboratory.....	128
Figure 52 – KUAR measured power in dB for a -20 dBm tone at 5.31 GHz transmitted over the air in the laboratory.....	129
Figure 53 – KUAR measured power values with a correction factor for a -20 dBm tone at 5.31 GHz transmitted over the air in the laboratory.....	129
Figure 54 - KUAR measured relative power values for a -15 dBm tone at 5.31 GHz transmitted over the air in the laboratory.....	130
Figure 55 - KUAR measured power in dB for a -15 dBm tone at 5.31 GHz transmitted over the air in the laboratory.....	130
Figure 56 - KUAR measured power values with a correction factor for a -15 dBm tone at 5.31 GHz transmitted over the air in the laboratory.....	131
Figure 57 - KUAR measured relative power values for a -10 dBm tone at 5.31 GHz transmitted over the air in the laboratory.....	131

Figure 58 - KUAR measured power in dB for a -20 dBm tone at 5.31 GHz  
transmitted over the air in the laboratory ..... 132

Figure 59 - KUAR measured power values with a correction factor for a -10 dBm  
tone at 5.31 GHz transmitted over the air in the laboratory ..... 132

## List of Tables

Table 1 – Radio frequency bands.....	4
Table 2 – Synchronized tables .....	50
Table 3 – Sweep Set Name table definition.....	51
Table 4 – Sweep Set Definition table definition.....	52
Table 5 – Organization table definition .....	53
Table 6 – Analyzer Settings table definition.....	56
Table 7 – Antenna table definition.....	58
Table 8 – Sweep Set Instance table definition.....	60
Table 9 – Measurement-<GUID> table definition .....	62
Table 10 – Sweep-<GUID> table definition.....	63
Table 11 – HP 8594E analyzer specific parameters .....	71
Table 12 – IFR 2398 analyzer specific parameters.....	71
Table 13 – Power loss for Times Microwave LMR-600 coaxial cable .....	93
Table 14 - Classification probabilities for FM band spectrum measurements .....	104
Table 15 – Measurement site GPS coordinates .....	108
Table 16 – Signal Generator and Spectrum Analyzer power measurement verification .....	112
Table 17 – Comparison of tone power measurements on KUAR and HP Spectrum Analyzer .....	114

## List of Terms and Abbreviations

AM	Amplitude Modulation
CDF	Cumulative Distribution Function
CR	Cognitive Radio
DSA	Dynamic Spectrum Access
ERP	Effective Radiated Power
FCC	Federal Communications Commission
FFT	Fast Fourier Transform
FIFO	First In – First Out
FM	Frequency Modulation
FPGA	Field Programmable Gate Array
GPS	Global Positioning System
GUID	Globally Unique Identifier
I2C	Inter-Integrated Circuit
ISM	Industrial, Scientific and Medical
ITTC	Information Telecommunications and Technology Center
KUAR	Kansas University Agile Radio
NPRM	Notice of Proposed Rule Making
NRNRT	National Radio Network Research Testbed
NTIA	National Telecommunications and Information Administration
PLL	Phased Lock Loop
RF	Radio Frequency
SA	Spectrum Analyzer
SDR	Software-Defined Radio
SG	Spectrum Generator
SMDS	Spectrum Miner Database Schema
SSH	Secure Shell
UNII	Unlicensed National Information Infrastructure

## Chapter 1 – Introduction

The growing demand for wireless services and applications shows no sign of abating. However, the current command-and-control<sup>1</sup> regulatory structure for licensing spectrum has been unable to cope with the drastic growth demands of the wireless industry [1]. This has given rise to an “artificial scarcity” of usable spectrum, resulting in spectrum license pricing that is prohibitively expensive. This in turn has a chilling effect on innovation and small business development, preventing many small to medium size businesses from entering the wireless market [2]. When spectrum licenses are awarded, the licensee must meet various technical and policy restrictions that govern the usage of the license, but there is no governmental mandate regarding how efficiently a communications band must be used. Outside of broadcast bands, very few communications services fully utilize their allocated bandwidth over a twenty four hour period. For example, a pizza delivery service may have a land mobile license that covers a metropolitan region and yet they may only use their licensed band business hours. In an efficient spectrum re-use scenario, the delivery service could license their spectrum to another party when they are not using it. The band could also be classified as a dynamic spectrum access (DSA) band, where secondary users look for the existence of a primary signal before using the band. Unfortunately, there is currently a lack of policy and technology solutions that enable efficient spectrum re-use in communications bands where licensees are not efficiently utilizing the band.

Given that there is a finite span of spectrum that is usable for communications services, various studies have begun to examine the efficiency licensed band usage. These studies aim

---

<sup>1</sup> A reference to centrally controlled disbursement of spectrum licenses by the FCC and NTIA

to help the regulatory community re-think the spectrum licensing regime with the goal of opening underutilized “prime” spectrum for licensed and unlicensed secondary usage [3]. Critical to the various studies that advocate changes in policy and technology is the accurate measurement of the spectrum. These measurements must be accompanied by signal detection and analysis methods that can impart meaning to the measurements and provide the theoretical basis for policy and technology development. This type of development is especially crucial in the burgeoning field of cognitive radio (CR) development. While several organizations and entities have performed spectrum measurement campaigns, a framework does not currently exist that enables and coordinates distributed spectrum measurements.

This thesis will detail the design and implementation of a framework that enables multiple organizations to coordinate distributed spectrum measurement campaigns, share data and further the analysis of spectrum utilization. This includes the design and development of a shared database schema for storing and synchronizing spectrum measurements. It also includes the development of a measurement automation program and central repository for the entire research community to share measurements. Finally, this thesis addresses the development of hardware and software that allows a low cost, mobile software-defined radio (SDR) platform to act as a spectrum analyzer (SA). This thesis and its associated work for the National Radio Network Research Testbed (NRNRT) project at the University of Kansas attempts to provide the scientific and governmental communities with spectrum data collection mechanisms and analysis techniques that can provide guidance in the formulation of future spectrum policy.

## 1.1 What is spectrum?

Spectrum is defined as a range of frequencies for electromagnetic waves. In the context of this thesis, it will refer to electromagnetic spectrum that has properties making it conducive for use as a communications medium. The frequency of these waves is typically measured in Hertz (Hz) or cycles per second, and is proportional to the wavelength. Electromagnetic waves are capable of transporting energy through space. In free space, this happens at the speed of light, or  $3 \times 10^8$  m/s. Spectrum is sometimes referred to as the “electrospace” and can be expressed as a tuple or hyperspace with dimensions of frequency, time, spatial extent, signal format, angle of arrival and polarization [4]. These properties define the ways in which electromagnetic waves can be manipulated for the purpose of carrying information.

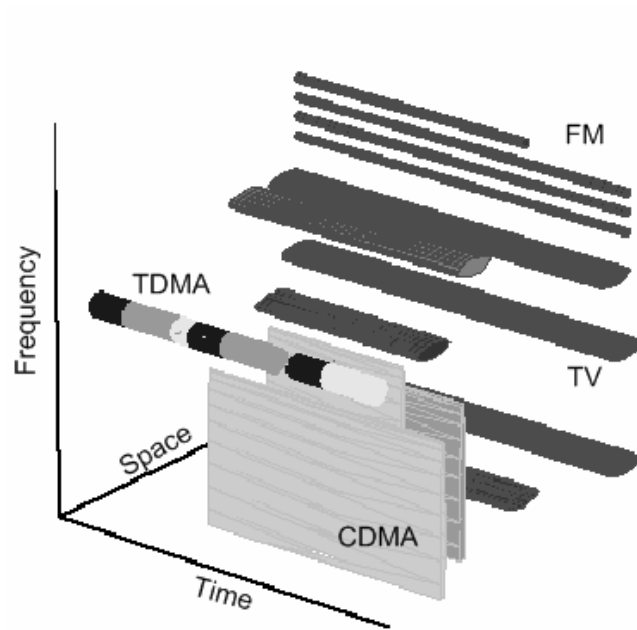

Figure 1 – The Electrospace represented in its three most basic dimensions [5]

The inverse-square law dictates that the power of an electromagnetic wave is proportional to the inverse square of the distance it has radiated from its source. Thus a receiver that has doubled its distance from the transmitter would see power levels that are one-quarter of the previously detected value.

$$\rho_P \propto \frac{1}{r^2}$$

**Figure 2 – Inverse square law**

Certain frequencies are desirable for telecommunications purposes because their wavelengths have favorable propagation qualities. For example, television and radio waves are capable of penetrating the walls of buildings, while higher frequency waves such as light cannot. These properties can contribute to the monetary valuations applied to spectrum. Lower frequencies are typically used in broadcasting applications and their ability to propagate over large geographic areas generally makes them a valuable commodity. Higher frequencies are advantageous in the realm of micro-electronics, such as cell phones, as their small wavelengths allow devices to use proportionally small antennas. Table 1 shows the various bands of the radio frequency (RF) spectrum.

**Table 1 – Radio frequency bands**

<b>Band</b>	<b>Frequency</b>	<b>Wavelength</b>
VLF – Very Low Frequency	3 - 30 kHz	100 - 10 km
LF – Low Frequency	30 - 300 kHz	10 - 1 km
MF – Medium Frequency	300-3000 kHz	1000 -100 m
HF – High Frequency	3 – 30 MHz	100 – 10 m



VHF – Very High Frequency	30 – 300 MHz	10 – 1 m
UHF – Ultra High Frequency	300 – 3000 MHz	100 – 10 cm
SHF – Super High Frequency	3 – 30 GHz	10 – 1 cm
EHF – Extremely High Frequency	30 – 300 GHz	10 – 1 mm

What makes the electromagnetic spectrum unique as a medium is that its waves can be used to carry a message or more generally, information. Modulation is the process of varying a periodic waveform in order to transmit information. This is similar to how a musician can convey different emotions or feelings in his music by varying the volume, timing and pitch. The most basic types of modulation involve varying the phase, frequency or amplitude of the carrier signal.

## **1.2 Research Motivation**

In the United States, the federal government controls the allocation and licensing of spectrum. Spectrum is allocated into bands and then licenses for various services are either awarded to or purchased by private entities (Figure 3). These entities are then free to use the spectrum as they see fit, even if this means that the spectrum lies dormant or is inefficiently used. This is highlighted in the Media Access Project’s Ex Parte comments filed on FCC ET Docket No. 03-237 [6]:

“As an initial matter, incumbents have a lengthy history of using the existing lack of clarity surrounding interference risk management to create artificial barriers to new technologies that threaten incumbents’ business models. Recent examples include resistance to the introducing of ultra-wide band technologies, technologies for

sharing Ku-band spectrum, and creation of a low power radio service. In all of these cases, incumbents succeeded in delaying introduction of innovative and competitive services and in scaling back the initial proposed services by exploiting the lack of any clear metric for interference risk management.”

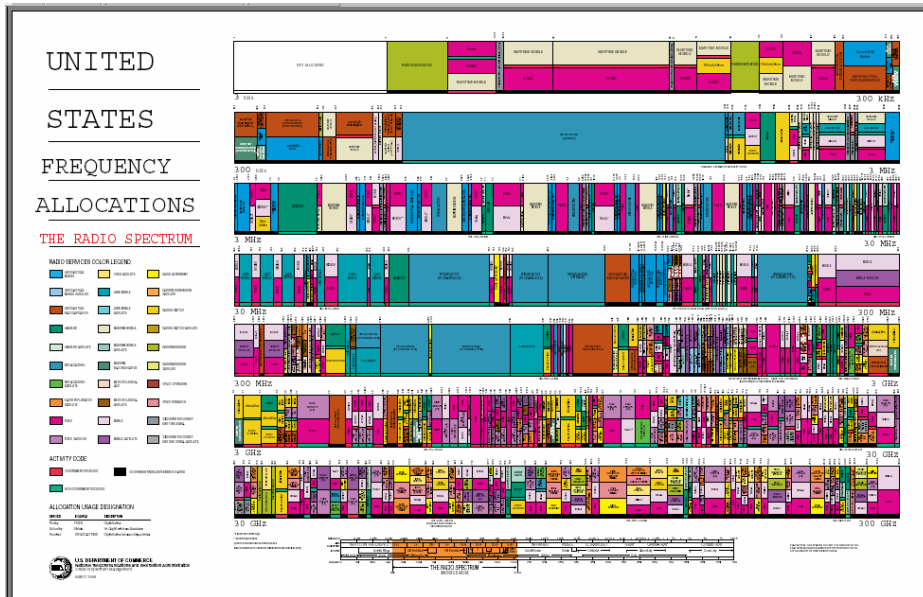

**Figure 3 – FCC spectrum allocation chart**

Communications bands can be allocated on either a nation-wide or regional basis. For example, PCS band cellular allotments are often nationwide. In contrast, there are numerous local network television affiliates in the country that have the same television channel assignment, but they are geographically separated so there is no chance of interference. These geographic spectrum markets help to protect against service interference, but can often be the source of inefficient spectrum use where spectrum is allocated but not licensed. As seen in

Figure 4, television channels 2-69 are allocated on a per-market basis nationwide. A majority of this spectrum goes unused in a high percentage of markets because the spectrum allocation outpaces the number of television broadcasters. This means that hundreds of megahertz of prime broadcasting spectrum goes unused around the country on a daily basis [7]. The propagation characteristics of this spectrum would make it ideal for rural wireless broadband access networks, surplus public safety spectrum, or secondary (unlicensed) spectrum for cognitive radio networks.

Market	Post-DTV Transition	
	No. of Vacant Channels Between 2-51	Percent of TV Band Spectrum Vacant
Juneau, Alaska	37	74%
Honolulu, Hawaii	31	62%
Phoenix, Ariz.	22	44%
Charleston, W.V.	36	72%
Helena, Mont.	31	62%
Boston, Mass.	19	38%
Jackson, Miss.	30	60%
Fargo, N.D.	41	82%
Dallas-Ft. Worth, Tex.	20	40%
San Francisco, Calif.	19	37%
Portland, Maine	33	66%
Tallahassee, Fla.	31	62%
Portland, Ore.	29	58%
Seattle, Wash.	26	52%
Las Vegas, Nev.	26	52%
Trenton, N.J.	15	30%
Richmond, Va.	32	64%
Omaha, Neb.	26	52%
Manchester, N.H.	23	46%
Little Rock, Ark.	30	60%
Columbia, S.C.	35	70%
Baton Rouge, La.	22	44%

**Figure 4 – White Space as a share of TV band in sample U.S. media markets [7]**

Numerous individuals, including former FCC Chairman Michael Powell, have voiced the notion that spectrum policy in the United States is antiquated. In a speech at the University of Colorado at Boulder [8], he said, "...we are still living under a spectrum "management"

regime that is 90 years old. It needs a hard look, and in my opinion, a new direction". The United States spectrum policy and its current "spectrum scarcity" stems from regulations created in the early 1920's. The advent of commercial radio broadcasts and the desire to prevent interference among transmitters gave rise to a rigid and exclusive licensing structure that is still in use today. This structure served powerful broadcast technologies like radio and television well, but has begun to show its shortcomings with the emergence of new technologies like cellular communications. In an article encouraging further deregulation of the spectrum, Thomas Hazlett and Gregory Rosston commented that [9]:

"Wireless operators are typically licensed to offer specific services, according to technologies and business models bureaucrats prescribe. Government mandates, for instance, forced analog cellular phone systems on a 1980s world that yearned to be digital. Worse, restrictions keep licensees in one band from offering services to compete with those in another, as in the UHF TV mandate."

These regulations aimed to promote harmony on the airwaves, yet they have put artificial limits on technology and have failed to efficiently utilize the spectrum as a resource. Modern advancements in technology however are displacing old ideas about interference, spectrum scarcity and spectrum sharing. Interference is not an inherent property of spectrum; rather it is a property of devices. This realization, amongst others, has led the FCC to regroup. In 2002, the FCC organized a Spectrum Policy Task Force to re-evaluate spectrum allocation and licensing. This task force found that a majority of the licensed spectrum, including premium frequencies below 3 GHz, is quiet most of the time. By making even small amounts of this bandwidth available, the door could be opened for a variety of new services. For

example, at least five digital TV shows can be broadcast on the same frequencies that a single analog channel now occupies. Satellite radios deliver service using just 25 MHz of spectrum, about the same bandwidth used by four analog television channels. The Personal Communications Service band used for cellular voice and data services contains 50 MHz of bandwidth. The IEEE 802.11 standard in wireless local-area networking was started with only 84 MHz. These examples demonstrate the types of services that can flourish with just a small amount of bandwidth. The variety of new services and industries that are made possible by access to affordable spectrum is virtually limitless.

While forward steps have been taken, regulatory change has been slow. Government officials still cling to rigid allocations of spectrum, which creates artificial scarcity and drives the price for licenses up. While this methodology may generate increased federal revenue, examples such as the deregulation of the ISM and UNII bands and the fantastic success of Wi-Fi demonstrates that the benefits of the free-market far outpace profits from licensing. New technology is gradually dictating that the entire notion of spectrum allocation should be overhauled to keep pace with public, private and governmental consumption of wireless services. Recent advancements in receiver and antenna technology have shown that signals can overlap without the interference problems experienced years ago. Advancement in wireless technology must be paired with progress in the policy and regulatory sphere if new wireless devices are to reach the consumer. To enable this progress, research must be performed regarding the study of real-world spectrum utilization patterns with respect to location and time.

### **1.3 The National Radio Network Research Testbed (NRNRT) project**

This thesis stems from the goals of the National Radio Network Research Testbed (NRNRT) project at the University of Kansas. This project aims to thoroughly analyze national spectrum usage and to coordinate the various spectrum measurement efforts currently underway. The dramatic development of wireless services and mobile communications devices underscores the fact that the public expects to have access to networks and information at all times and in all locations. Spectrum allocation and usage may be re-thought in order to facilitate continued economic growth of communications services in the open market. The NRNRT project aims to answer the following questions:

- What are the characteristics of the wireless environment over long time periods and broad frequency ranges?
- How should sensor networks be built and deployed to best measure the wireless environment?
- How can the RF environment be sounded over a wide frequency range without interference and remaining within the constraints of government regulations?
- How can wireless measurements be mapped to accurate network-level simulation models?
- How can the characterized RF environment be used for testing and evaluation of novel wireless systems?
- How can RF measurements be effectively integrated into emulation/simulation systems?

The NRNRT will support the research and development of new radios, services, architectures, and protocols that will power the next generation of wireless access. The NRNRT also proposes to provide a facility for the research community to test and evaluate their systems. The NRNRT consists of the following programs and systems:

1. A field deployed measurement and evaluation system for long-term radio frequency data collection.
2. An experimental facility for testing and evaluating new radio devices
3. An accurate emulation and simulation system incorporating long-term field measurement for evaluating new wireless network architectures, policies and network protocols.
4. Coordination of experiments with innovative wireless networks that integrate analysis, emulation/simulation and field measurements.

Field measurements produced through the NRNRT will provide real spectrum usage data that can be used as the input to simulations or to test new radio designs. A centralized database will store long-term utilization and propagation statistics from RF spectrum measurements. The emulation system will aid in improving the analysis of radio devices, protocols and services. All of these services will help aid designers in testing their next generation designs. The research and coordination provided by the NRNRT will help shape spectrum management and policy discussion at the national level.

## ***1.4 Research Objectives and Contributions***

This thesis will detail the design and implementation of a framework that enables multiple organizations to coordinate distributed spectrum measurement campaigns, share data and

further the analysis of spectrum utilization. This includes the design and development of a shared database schema for storing and synchronizing spectrum measurements. It also includes the development of a measurement automation program and central repository for the entire research community to share measurements. Finally, this thesis addresses the development of hardware and software that allows a low cost, mobile software-defined radio platform to act as a spectrum analyzer. This thesis and its associated work for the National Radio Network Research Testbed (NRNRT) project at the University of Kansas attempts to provide the scientific and governmental communities with spectrum data collection mechanisms and analysis techniques that can provide guidance in the formulation of future spectrum policy.

## **1.5 Thesis Outline**

Chapter 1 provides an introduction to the radio frequency spectrum. It discusses the research project that this thesis is associated with and covers the objectives and contributions of the thesis. The outline of the thesis is presented in this subsection.

Chapter 2 discusses the regulatory and policy history concerning spectrum management in the United States. This provides insight into the current situation of spectrum scarcity. The subjects of spectrum measurement and signal detection are reviewed. These are related to the development of software-defined and cognitive radios, which promise to make dynamic access networks a reality in several underutilized communications bands. Finally, the development of the Kansas University Agile Radio platform is discussed, which will provide insight into the use of this radio as an experimental platform. In the case of this thesis, the



versatility of the KUAR will be demonstrated through its use as a spectrum data collection device.

Chapter 3 highlights the design of a shared database schema, spectrum measurement automation program and centralized measurement repository. The database design is discussed table by table, as design decisions have a direct impact on the ability of the database to store large amounts of spectrum data and to easily facilitate sharing of the data amongst multiple researchers. The ability to import and export that data to a variety of analysis tools is addressed.

Chapter 4 covers the implementation of the Spectrum Miner program, a software tool for measurement automation. This program can interface with a variety of spectrum data collection devices, including spectrum analyzers and software-defined radios configured to work as simple spectrum analyzers. This section also includes a discussion of the work involved to allow the KUAR radio to act as a spectrum analyzer and interface with the Spectrum Miner program. The program's user interface and usage is demonstrated as well. Finally, this chapter addresses the implementation of the Spectrum Repository, a web application and archival database designed to coordinate measurement gathering and data sharing.

Chapter 5 highlights how the tools and techniques developed during the creation of this thesis can be used to perform spectrum measurement campaigns. The calibration and verification of measurements is addressed. Two case studies are presented that demonstrate how real-world measurements were performed and analyzed.

Chapter 6 offers concluding thoughts and summarizes the research and development accomplished in the thesis. Ideas regarding future work related to topics addressed in the thesis are suggested and examined.

Appendix A displays Matlab code that is used to import spectrum measurements directly into the Matlab workspace. Appendix B provides plots of the calibration measurements taken on the KUAR.

## **Chapter 2 – Background**

### ***2.1 Regulatory History***

The U.S. Radio Act of 1912 marked the beginning of governmental regulation of radio as a communications medium. This act allowed the Department of Commerce to issue commercial radio licenses. As many organizations and individuals applied for these licenses, further oversight became necessary. The Radio Act of 1927 created the Federal Radio Commission, an independent commission that could grant exclusive radio licenses to a limited number of broadcasters [10]. As spectrum usage increased in both the public and private sectors, various government agencies became increasingly responsible for the management of the spectrum. The Communications Act of 1934 helped to define the various responsibilities of government agencies for spectrum management in the United States. This act created the Federal Communications Commission (FCC), an independent agency under the auspices of the executive branch. This agency replaced the Federal Radio Commission and was tasked with a broader mandate of managing all non-federal government spectrum utilization. This includes regulating interstate and international communications by radio, television, wire, satellite and cable.

The FCC coordinates spectrum management with The National Telecommunications and Information Administration's (NTIA) Office of Spectrum Management. The NTIA is a branch of the Department of Commerce and is responsible for managing the spectrum needs of the federal government [11]. The NTIA and FCC coordinate with other Federal agencies that require spectrum usage through the Inter-department Radio Advisory Committee

(IRAC). This committee includes the Department of Defense (DoD), which is the largest governmental spectrum user. The DoD Joint Spectrum Center also works directly with the NTIA to allocate and secure spectrum for defense and national security purposes. The NTIA and FCC have divided approximately 300 GHz of usable radio spectrum into three categories: government exclusive, non-government exclusive and shared bands. This allocated spectrum has been divided into roughly 900 bands that are usable for various radio communications services including television and radio broadcasting, land mobile, and fixed and mobile satellite communications. The FCC makes domestic spectrum allocations through a public rulemaking process, often inviting public comment. Historically, spectrum licenses were awarded by either outright assigning a licensee or by holding competitive hearings to determine the licensee that would most exemplify operation in the public interest. This license process is often referred to as a “beauty contest”. This process changed slightly in 1982 with the introduction of a lottery system that could be used to assign licenses [12]. The Congressional Omnibus Budget Reconciliation Act of 1993 replaced the lottery system with an auction-based system [13].

## **2.2 Spectrum Scarcity**

With 300 GHz of licensable spectrum, it would appear that there is no shortage of usable spectrum for wireless communications. In fact, the FCC and NTIA have even begun allocating and licensing higher frequency spectrum. Despite this seemingly immense allotment, the vast majority of “prime spectrum” exists in the 0 to 3 GHz range. This so-called “prime spectrum” denotes frequency ranges with physical properties that lend themselves to long-range broadcasting and wireless communications applications. Wireless operation is possible at higher frequency bands (millimeter wave, radar), but it often requires

line of sight between the transmitter and receiver and it can heavily attenuate due to various environmental or atmospheric conditions. These physical properties influence the fact that over 93 percent of all FCC licensees and Federal government frequency authorizations are in the 0 to 3 GHz range [14]. Below 3 GHz, spectrum is currently allocated in the following manner:

- 14 percent of the spectrum is Federal government exclusive
- 31 percent is non-Federal government exclusive
- 55 percent is shared between the Federal government and private sector

In prepared testimony before the United States House of Representatives Subcommittee on National Security, Veterans Affairs, and International Relations, former NTIA Deputy Assistant Secretary Michael D. Gallagher highlighted the licensing problems that exist in prime spectrum ranges [14]:

“The entire spectrum management process has to be flexible, dynamic, adaptable to changing requirements, and timely to meet the national needs for spectrum. The spectrum below 3 GHz is extremely congested. Thus, finding spectrum below 3 GHz for the deployment of new technologies, such as third generation wireless or ultra-wideband services, has been a complex and challenging process.”

Gallagher continued to outline the steps that the Federal Government has taken to open various government licensed bands to the private sector:

“As a result of the requirements of the Omnibus Budget Reconciliation Act of 1993 and the Balanced Budget Act of 1997, NTIA has identified over 240 MHz of spectrum used either exclusively by the Federal government or shared with the

private sector for reallocation to private sector uses. In 1998, Congress enacted a law that requires the private sector beneficiaries of this spectrum to reimburse Federal agencies for the costs of relocating from certain of the identified frequency bands. NTIA is now in the process of finalizing these reimbursement rules.”

In June 2002, the FCC formed the Spectrum Policy Task Force (SPTF) to help with identifying and evaluating changes in spectrum policy. This commission was tasked with providing guidance in making spectrum regulation more market-oriented, moving towards unlicensed device or commons models, and minimizing regulatory intervention. In November 2002, the SPTF released a report that recommended moving certain spectrum from a command and control infrastructure to both unlicensed and licensed flexible-use policies [15]. After the release of this report, the FCC began several proceedings to follow through on the SPTF’s recommendations. Many of these proceedings however have focused on granting flexible use rights to incumbent spectrum license holders. There has been little work in opening up new unlicensed bands [16].

### **2.3 *Dynamic Spectrum Access***

Advances in radio technology, coupled with a burgeoning spectrum scarcity, have made spectrum regulators turn to the idea of allowing dynamic spectrum access in specific bands. Dynamic spectrum access is not a completely new idea however, as this concept has been in use around the world for many decades [17]. For example, the British CT2 system, which is a cordless telephone technology, has employed dynamic spectrum sharing. The phone system was allocated 4 MHz of spectrum, divided into 40 channels. Upon receiving a call, the base

station scans the available channels to find an empty channel. This method makes use of a time-varying frequency-division multiplexing scheme.

Another form of dynamic spectrum sharing can be found in the area of maritime radio. Maritime radio uses a common signaling frequency for emergency signaling and for establishing communication between ships. If one ship needs to make a call to another, the signaling frequency is used to select an empty working channel. Traditional Land Mobile Radio systems also typify the dynamic spectrum access approach. For example, a garbage disposal service and a taxi service might share a single channel in a city. The use of protocols like Listen Before Talk (LBT) and short messages allow both services to efficiently use a single channel. In many cases, the channel utilization could also vary with time, as the garbage service may heavily use the channel from 9 AM to 5 PM. During the evening hours, there may be very little voice traffic from the garbage company, whereas the taxi company may be increasing its utilization of the channel. Over time, more complex radios using techniques like tone-coded squelch have allowed various groups sharing a channel to partition their messaging. The Citizen's Band (CB) radio service can also be viewed as an example of dynamic spectrum access. This 27 MHz band, divided into 40 shared channels, does not require a license for operation. Channel 9 is typically reserved for emergency communication. Enforcement and regulation of the CB band is basically non-existent. The FCC has regulated power limits on equipment, but users are still capable of amplifying their signal above legal limits. In many ways, the CB band presents an apt analogy to the current, more modern proposals involving unlicensed, cognitive radios and dynamic spectrum access.

It has been shown that several spectral bands, most significantly the television spectrum, are underutilized [3]. There has been recent regulatory and legislative activity that could allow new wireless devices to access television band “white space” on a per market basis. These unused channels, often referred to as “white space” because of their lack of activity, could be accessed and utilized through dynamic spectrum access techniques. This would allow unlicensed devices (UD) to transmit in licensed or unlicensed television bands as long as a television signal is not present.

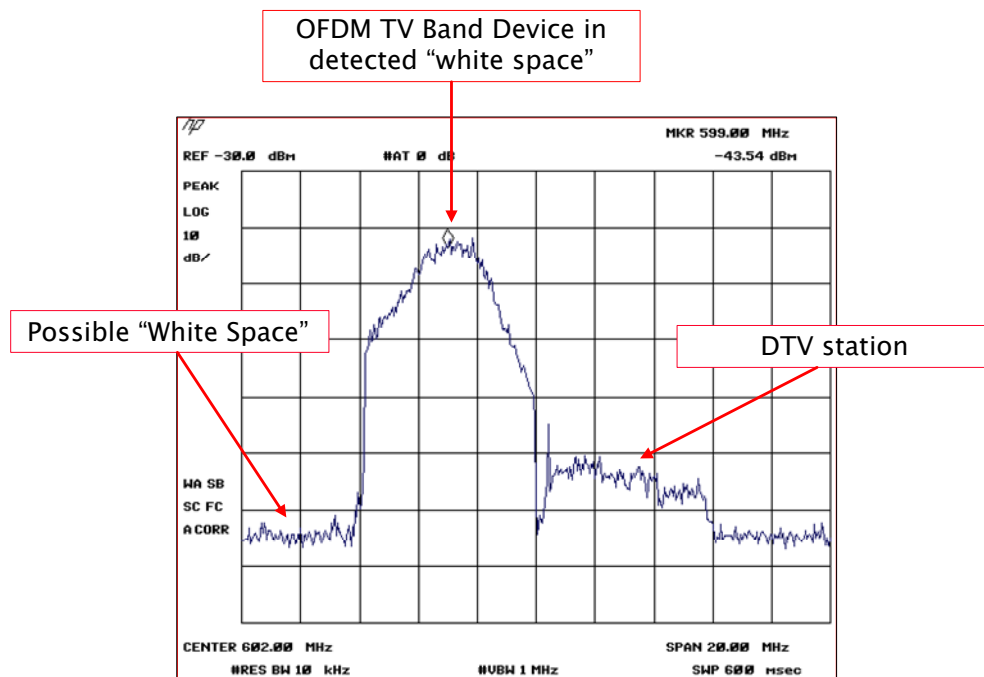

Figure 5 – Example of whitespace and unlicensed device operation in DTV band [18]

On June 28, 2006, the Senate Commerce Committee adopted ‘The Advanced Telecommunications and Opportunity Reform Act of 2006’ (S. 2686), which built upon the



May 2004 Federal Communications Commission (FCC) Notice of Proposed Rulemaking (NPRM) [19] allowing unlicensed devices to utilize unused spectrum in the TV band. This legislation requires the FCC to continue with rule making procedures (Docket 04-186) governing the opening of TV channels 2-51 (54 MHz - 698 MHz) for use by wireless broadband services and DSA capable devices. The FCC proposal also includes the reallocation of TV channels 52 - 69 (698 MHz to 806 MHz) for auction and additional public safety communications bands. The NPRM specifies that any devices certified to use TV “white spaces” should use agile or cognitive radio technology in a dynamic spectrum access configuration, such that these devices would not interfere with primary rights holders (primarily television broadcasters).

Dynamic spectrum access often carries with it the notion of primary and secondary users. Contrary to an unlicensed band, in which all users compete or cooperate to share bandwidth, dynamic spectrum access often takes place in a licensed band. In this case, the primary user or license holder has incumbent rights to use the band. In a DSA approach, the secondary users must not cause any “harmful interference” to the primary users as well as the other unlicensed users sharing the same portion of the spectrum. Since primary users hold exclusive rights to the spectrum, it is not their responsibility to mitigate any additional interference caused by unlicensed or secondary device operation. These devices will have to periodically sense the spectrum to detect primary or secondary user transmissions and should be able to adapt to the varying spectrum conditions [20].

The television band will have an increased amount of unused spectrum or “white space” after the federally mandated analog to digital television (DTV) transition, the deadline for which is February 17, 2009 [21]. As stated above, the DTV transition will designate channels 52

through 69 for auction and public safety use. Examining DTV broadcasters on a per-market basis, an average of only seven full-power DTV stations will be operating on channels 2 through 51 in each of the country's 210 local television markets. This means that on average, only 42 MHz of the 294 MHz of prime spectrum allocated to DTV services will actually be utilized [22]. The availability of underutilized TV spectrum is rarely disputed within the academic and research community. The issues regarding the use of this spectrum however require solutions and cooperation involving the technical, regulatory and business communities. The regulatory community must determine the technical rules that secondary devices must use to prevent harmful interference with primary devices (i.e. DTV receivers). Additionally, the device manufacturing community must determine if cost effective devices can be created that operate efficiently and correctly (with respect to technical rules) in a co-channel environment to DTV transmissions.

Substantial research efforts are underway that aim to find efficient ways of utilizing vacant portions of the TV spectrum using DSA techniques. The new IEEE 802.22 standard focuses on technical implementations that can accomplish spectral reuse without causing harmful interference to primary users [23]. Some of the important issues that have been addressed include the feature detection of TV signals [24], collaborative sensing for improved detection capabilities [25], detection of the presence of receivers in the vicinity of the unlicensed device [26], and effective methods for the unlicensed spectrum access in the TV band [27].

## **2.4 *Spectrum Measurement***

International regulatory bodies and national governments control the allocation of spectrum. In the United States, the Federal Radio Act of 1927 set in motion regulatory action that declared the airwaves public property and put them under the guardianship of what would

eventually become the FCC. Thus the federal government, and not the free market, became the steward of spectrum within the United States. As the FCC began issuing licenses and engaging in spectrum auctions, both government regulators and private entities have been interested in both how spectrum is used in practice and how to measure its utilization. This interest is rooted primarily in compliance enforcement, but also focuses on analyzing spectrum utilization. According to the SPTF Spectrum Efficiency Working Group report [28]:

“Neither FCC nor NTIA routinely quantify actual spectrum usage by users under their jurisdiction. However, during the Summer of 2002 the FCC’s Enforcement Bureau took limited measurements of spectrum use in certain urban areas which allow a partial view of actual spectrum use. This effort was limited in duration and only used one site in each city studied, and hence generally underestimates actual spectrum use to some degree. However, the Working Group believes that the general observations made here are likely to have broad applicability and should be verified in a broader measurement program, possibly in conjunction with noise measurements.”

While there is no federal program to measure and characterize spectrum usage, compliance certification, interference resolution and single-site spectrum measurement is often managed through the NTIA’s Office of Spectrum Management (OSM). The NTIA OSM has developed a Radio Spectrum Measurement System (RSMS) that tracks radio spectrum usage and attempts to resolve interference problems in the field [29]. This spectrum measurement and analysis system is mounted onto a truck or other vehicle for mobile troubleshooting and measurement purposes.



**Figure 6 – NTIA mobile Radio Spectrum Measurement System (RSMS)**

The system contains manual, semi-automated and automated systems for measuring radio emissions from a variety of systems including high-power radars, mobile radios and associated base stations, navigation beacons, point-to-point microwave links, lower power FCC Part 15 devices and ISM devices [30]. The trucks feature an extensible antenna mast, often rising over 9 meters, so that it can gain decent line of sight to a variety of signal sources. The RSMS system has been used to measure and analyze various communications bands. This system was used during the 1996 Summer Olympic Games in Atlanta to characterize and measure land mobile radio usage in a high capacity scenario [31].

Regulatory bodies around the world also perform compliance testing and single-site spectrum measurements. Ofcom, the United Kingdom’s equivalent to the FCC in the U.S., has often hired engineering consulting companies to perform measurement campaigns at various sites

throughout the UK [32]. These studies are aim to provide per-band relative time and frequency utilization statistics that approximate spectrum usage across the entire UK.

The academic and research communities have initiated various spectrum measurement programs to measure and quantify the use of spectrum in various common scenarios. These programs often involve measurement campaigns in urban, suburban and rural settings. The Shared Spectrum Company (SSC) has performed several important spectrum measurements, especially those taken in downtown Washington, D.C. and taken during the Republican National Convention in New York, NY. These two measurement campaigns provide spectrum usage profiles of media markets with dense license allocation and heavy communications usage. In Washington, D.C., spectrum licenses are densely allocated due to the wide variety of government and consumer communications services in use. Shared Spectrum Company performed a four-hour measurement on the roof of the National Science Foundation building in Arlington, VA. The average spectrum utilization was found to be less than 11.4% for the span of 30 MHz to 3 GHz [33]. The RNC measurements are important because New York is one of the densest spectrum markets and during this time period there was heavy usage in governmental bands by the Department of Homeland Security, FBI and local police. Two measurements were performed, each covering a twenty-four hour period. While this measurement campaign found high occupancy in government bands and in the lower TV channel band (77%), the average spectrum usage from 30 MHz to 3 GHz was found to be 13% or less [34]. Allen Petrin and Paul Steffes of the Georgia Institute of Technology have also performed several long-term spectrum measurement campaigns. Their measurements were taken in urban, suburban and rural settings in and around Atlanta, GA. They accumulated more than 8 billion spectrum measurements over the course of several

months. Their geospatial analysis of spectrum usage shows that only 6.5% of urban spectrum, 5.3% of suburban spectrum and 0.8% of rural spectrum was utilized on average [35].

Academic and research studies have also focused on the utilization of ISM bands such as the 900 MHz and 2.4 GHz bands. The Naval Postgraduate School (NPS) has also performed spectrum occupancy studies for the 2.4 GHz ISM band and found that while these bands are often highly utilized in various temporal segments, the low power output of devices that operate in these bands means that this spectrum is often available with respect to geographic location [36] [37]. Reports from the NPS and Illinois Institute of Technology have also examined the interference profiles of common devices, such as microwave ovens or cordless telephones and the effect that these devices have on operation in the ISM bands [38] [39].

The Spectrum Efficiency Working Group, a subcommittee of the SPTF, issued a report which suggests that single-site spectrum measurements may not provide an accurate overview of actual spectrum utilization [40]. In a separate publication, researchers Mark McHenry and Dennis Roberson have noted the lack of a collaboration framework for spectrum measurements and research [41]:

“There needs to be a systematic measurement framework to collect distributed spectrum occupancy data. The sensitivity/occupancy results are dependent on the detector type used, the antenna height and other factors. These factors need to be made identical or normalized out to cross compare results between different locations. Also, the spectrum scan rate needs to be "tuned" to the experimental issue.”

The need for distributed measurement campaigns, repeatable experiment configurations and data exchange is at the core of this thesis and the National Radio Network Research Testbed (NRNRT) project. Research directed through NRNRT project will attempt to unify disparate measurement campaigns and provide sharing mechanisms for spectrum measurements.

### **2.4.1 Distributed spectrum measurements**

It is difficult to generally characterize spectrum usage over a large geographic area. This is due to a variety of reasons, including the propagation properties of various signals. Various projects have suggested using sensor networks composed of spectrum measurement or analysis nodes [42]. This approach, typically focused on detection for a specific band, could be deployed in either a building or across a metropolitan area. The dedicated sensor nodes provide the diversity required to detect short-range communications devices. These nodes could continuously or periodically sense the spectrum and perform localized signal detection. This information is then passed to a sink node that performs various data fusion algorithms. The spectrum data can then be correlated to various geographic locations based on signal propagation equations. This data can then be used for a variety of functions, including the operation of dynamic spectrum access networks. The nodes in these spectrum measurement sensor networks could be implemented by specific communications hardware or SDR-based cognitive radios [43]. The rapid reconfiguration capability of SDRs would allow this type of sensor network to perform spectrum measurements in a variety of bands. Research has been performed simulating cognitive radio networks that cooperatively sense and detect primary users, such as digital television [44] or cellular network signals [45].

## **2.5 Spectrum Sensing / Signal Detection**

Data garnered from spectrum measurement campaigns can be used to help design spectrum sensing and signal detection algorithms for cognitive radios. A feature of cognitive radios is that they can monitor the spectrum for unused channels or whitespaces. This can be implemented using the cognitive radio's RF front-end and digital signal processing capabilities or through the use of an external spectrum sensor [42]. There are several advantages and disadvantages to these two approaches. In the former case, the CR must dedicate time to sensing the given band. This affects throughput of the radio, as valuable communications time must be spent scanning and detecting the spectrum. This can also affect the development of medium access control (MAC) protocols. This design simplifies radio design, however, and provides better mobile battery life given that it does not have to power an external sensor. In the latter case, an external sensor can allow the radio to function normally while simultaneously analyzing the spectrum. Dedicated sensors can also be designed to analyze wide bandwidths very quickly, allowing for the radio to dynamically adapt to the channel environment. Unfortunately, these sensors often have deleterious effects on battery life and can complicate radio design.

Signal detection is an important component of spectrum sensing. Most advancements in signal detection relating to the field of communications stem from radar and other telecommunications research and development begun during World War II. This research focused on topics such as detecting aircraft by their radar signature, signal triangulation, or signal interception and decoding.



As discussed previously, spectrum is a hyperspace with dimensions including, but not limited to time, frequency, space, polarization, and code format. Therefore, it is important to detect the properties of various transmissions, as this may allow for the operation of another transmission orthogonal to the one being detected. Signal detection theory is centered on discerning a signal against noise. In communications bands, the “noise floor” is a metric describing the sum of all the desired signals, interfering signals and noise sources at a specific frequency, time and location. This includes licensed emissions, out-of-band or spurious signals, inter-modulation products, emissions from Part 15 devices, environmental noise from cars, machines or electronic devices and galactic radiation [28]. One way that spectrum licensees currently protect their transmissions from interference is through the creation of guard bands. This is particularly true in the television band. These guard bands often prevent co-channel interference, but at the expense of wasted spectrum. One concept that has been proposed is an “interference temperature” that shifts the focus from transmitter operations to the RF environment pertaining to the receiver. Interference temperature, measured in degrees Kelvin, is the RF power generated by undesired emitters and noise sources per unit of bandwidth that is present in a receiver system. This concept sets a protection threshold for incumbent users and allows secondary or unlicensed operation in the same band as long as the interference temperature threshold is not exceeded. The interference temperature underlay / overlay concept has also been used to perform spectrum occupancy measurements [46]. While this concept has been the subject of much academic research [47] [48], the Interference Temperature NPRM issued by the FCC has recently been terminated, due in large part to comments filed by incumbent license holders [49].

Radio receivers are tasked with the challenge of extracting desired signals from noise, sometimes in the case where the desired signal power is even beneath the measured noise floor. An optimal way of detecting and classifying a signal is through matched filtering. A matched filter correlates a known signal with an unknown signal by convolving a time-reversed version of the known signal with the unknown input. This method maximizes the SNR ratio of the received signal, but requires a priori knowledge of the signal. Another method of detecting signals is by using a non-coherent energy detector. This approach uses thresholding and the power spectral density of the received signal to determine if a signal exists in a given channel. This method however requires prior knowledge of the power characteristics of the desired signal and the channel under examination. Detection thresholds can be manually chosen or can be obtained using various statistical algorithms. Threshold-based classification of signals using detected energy can be improved using algorithms such as Recursive One-Sided Hypothesis Testing, Otsu's Algorithm and adaptive thresholding [50]. Energy detection works well in discretely channelized environments, but has difficulty distinguishing between modulated signals, noise and interference in the same channel. A way to resolve this ambiguity is through the use of feature detection. Feature detectors identify a signal by its specific spectral characteristics. One specific feature detector is the cyclostationary detector [44]. Modulated signals are cyclostationary processes, meaning that they have periodic auto-correlation functions. Different modulation schemes have distinct spectral correlation functions, making signal identification and selection possible. A final technique that can provide added resolution to any of the above methods is the use of antenna arrays at the receiver. These arrays can detect the angle of incidence of the transmission, which can be used to differentiate it from other transmissions in the same spatial area [51].

Underlying all of these detection methods are certain physical limits that bound the detection of a signal under high levels of noise uncertainty. Recent research has helped to define the physical limits of detection for sufficiently low SNR, termed as SNR “walls” [52]. No matter how precise the signal detection algorithm may be, signals that exist sufficiently beneath the noise floor are typically beyond detection or recovery.

## **2.6 Cognitive Radios**

Much of the research being performed in the areas of spectrum measurement and spectrum sensing has the goal of enabling cognitive radio development. Spectrum utilization measurements can help to shape spectrum-licensing regulations and provide real-time policy information to cognitive radio networks. If cognitive radios are capable of sensing the spectrum and identifying primary users, they may also be able to efficiently use under-utilized spectrum. Researchers have attempted to analyze spectrum usage with the goal of bootstrapping cognitive radio research and dynamic spectrum access policy and regulation [53].

### **2.6.1 Background**

The rapid evolution of microelectronics, wireless transceivers are becoming more versatile, powerful, and portable. This has enabled the development of software-defined radio technology, where radio transceivers perform baseband processing in software, reconfigurable hardware or programmable Digital Signal Processing (DSP) processors. Joseph Mitola first introduced the notion of a software-defined radio in the early 1990s [54]. The definition of an SDR is rather flexible, but it usually includes a RF front-end, analog-to-digital (ADC) and digital-to-analog (DAC) converters and software-controlled baseband

processing. The ease and speed of programming baseband operations in a SDR makes this technology a prime candidate for DSA networks. SDR technology advances the field of communications with respect to rapid prototyping, testing and deployment of new radio hardware and communications systems. New modulation schemes or coding techniques can be rapidly implemented and tested without building expensive custom hardware. SDR system software can be designed to interface with communications system design programs, thus enabling designers to rapidly move from simulation to implementation. Around 2000, Mitola proposed extending the capability of an SDR by adding the notions of environment sensing and artificial intelligence [55]. These SDRs with intelligence, termed Cognitive Radios (CR), are capable of rapidly reconfiguring operating parameters due to changing requirements and conditions at the physical, network, and/or application layers of the system [56]. These capabilities make it possible for cognitive radio systems and networks to flexibly and dynamically access the spectrum while simultaneously respecting the rights of incumbent license holders. Systems have been proposed that use various expert systems and rule engines [57], genetic algorithms [58], or ontology-based reasoning and inference engines [59]. These systems and algorithms aim to provide the CR with the knowledge necessary to assemble a strategy for dealing with the current RF environment, as well as primary and secondary users. Cognitive Radios can operate in self-forming networks that collaboratively sense the spectrum or interact with “spectrum servers” that function according to market-driven resource pricing and utility functions and dynamically allocate spectrum resources [60]. Research has also been performed that utilizes game theoretic approaches to spectrum utilization, in an attempt to prevent independent or autonomous Cognitive Radios from implementing “greedy” spectrum allocation algorithms [61]. This approach allows for

distributed dynamic spectrum allocation protocols, as opposed to a centralized “spectrum server” model [62].

### **2.6.2 KUAR**

The Kansas University Agile Radio (KUAR) platform [63] provides a low cost, flexible RF, small form factor SDR implementation that is both portable and computationally powerful. It is designed to address the real world needs of researchers in the fields of wireless networking, RF design, cognitive radios and dynamic spectrum access. The KUAR features a modular design consisting of separate power supply, digital processing, and RF sections. The current version of the radio operates in the 5 - 6 GHz band and is capable of implementing numerous modulation algorithms, media access control (MAC) protocols, and adaptation mechanisms. As shown in Figure 7, the KUAR consists of five major sub-systems on three printed circuit boards: a power supply, a control processor host (CPH), a digital board (DB) with a programmable signal processor, an ADC, DAC, RF transceiver and active antennas.

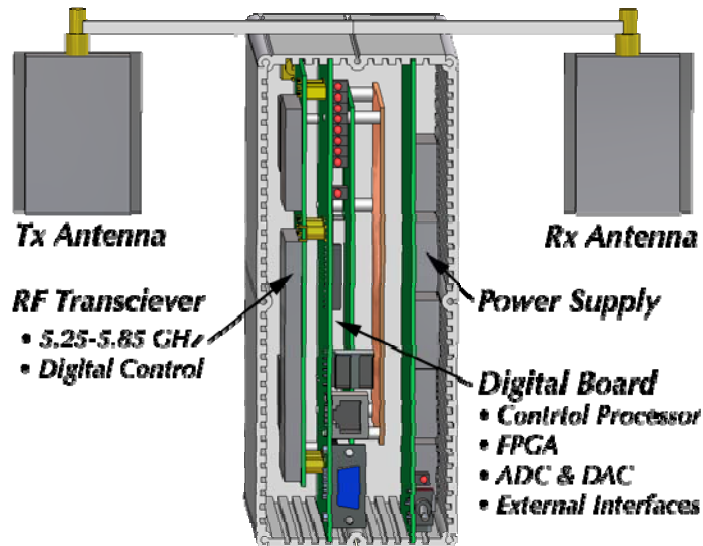

**Figure 7 – KUAR Radio**

The KUAR is approximately 7 inches tall, 3 inches wide and 6 inches deep. With the exception of the antenna housings, the sub-systems / PCB boards are contained within a shielded enclosure. The enclosure aids in providing physical separation between the active transmit and receive antennas. The RF Board uses standard SMA connectors, which allows the KUAR to use third-party commercial and experimental antennas. The KUAR's modular design allows for interoperability with other control processors, digital signal processing units or RF front-ends. For example, the KUAR control processor and digital processing board could be connected to other RF front-ends, enabling investigation or experimentation in other frequency ranges (Figure 8). Additionally, the KUAR active antennas, RF front-end, CPH or



CPH runs Linux and provides USB 2.0, VGA, PCI Express and Gigabit Ethernet (10/100/1000 Mbps) connections. This platform contains significant processing power compared to most embedded communications systems, and as such, provides great flexibility with regard to rapid radio reconfiguration, signal processing and cognitive/adaptive control software. Common personal computer interfaces, such as VGA output and USB allow the platform to be used as a standard PC while on the test bench or in the field. This greatly decreases the amount of test and evaluation equipment that must be carried during field tests.

The KUAR is capable of implementing digital communications components and systems in either software or reconfigurable hardware. Currently, the majority of digital signal processing is performed in reconfigurable hardware implemented in the Xilinx field-programmable gate array (FPGA) on the Digital board. The current KUAR version 3.0 radio contains a Xilinx Virtex II Pro P30 FPGA, which possesses 30,816 logic cells, two PowerPC 405 cores and operates at up to 350 MHz. The FPGA can be programmed and configured using command line utilities and software libraries accessible under the Linux distribution running on the CPH. Currently, programming and configuration commands are sent across the USB 2.0 bus to a Cypress USB peripheral controller. The FPGA hardware configuration that supports this is very space efficient, only requiring approximately 20 logic slices. This controller translates the configuration data sent over the serial bus to a parallel bus connected to the configuration pins of the FPGA. The configuration data rate is 48 Megabytes per second (MBps), which is near the 50 MBps limit of the FPGA. There are two other possible physical interfaces between the CPH and the FPGA. The fastest is a connection over the PCI Express bus, which provides data rates around 250 MBps, but takes approximately 7,000 logic slices to implement in the FPGA. To save logic space, a standard PCI bus connection



may also be used. The PCI bus connection provides a transfer rate of 130 MBps and only uses 500 logic slices. There is also a JTAG header on the Digital Board that connects to the FPGA for programming and debugging in the laboratory.

The KUAR has significant flexibility in locating signal processing functions in hardware logic, the embedded PowerPC processors or the CPH. This allows extremely parallel and time-sensitive operations to be moved into custom, reconfigurable hardware, and more complex operations to be implemented in software. Giving the system designer the fine-grained ability to determine whether an operation should occur in hardware or software allows for compact, efficient and innovative designs.

The KUAR RF front-end is a super-heterodyne design that takes input signals between 5.2 and 5.8 GHz, down mixes to 3.4 GHz and then down converts to base-band. The current transceiver bandwidth is 30 MHz, although future designs will employ larger bandwidths. Received signals in an in-phase/quadrature modulation scheme are converted to baseband by the RF board. Analog to digital sampling is handled by a Linear Technology LTC2284 dual ADC at up to 105 megasamples per second (MSPS) with 14 bit resolution per sample. Processed baseband signals are converted from digital to analog by an Analog Devices AD9777 DAC running at 100 MSPS with 16 bit resolution.

The KUAR RF module (left half of Figure 8) has been designed with experimental use in mind. Features include the ability to set independent transmit and receive frequencies, as well as digitally control the transmit power output and receive gain levels. Digital control of transmitter output power, receiver front end attenuation, and IF amplifier gain should prove to

be useful for fading channel experiments, and also allows researchers to perform experiments in test environments. The RF modules currently in use offer a frequency range of 5.25-5.85 GHz, and are designed for operation in the 5 GHz Unlicensed National Information Infrastructure (UNII) and Industrial, Scientific and Medical (ISM) bands. An RF design for 2.05-2.70 GHz operation is currently being developed.

## **2.7 Summary**

This chapter provides insight into the regulatory history and spectrum policy that defines the current wireless market. It also provides insight into the current state of dynamic spectrum access networks, spectrum sensing and detection, and spectrum measurement research within the context of cognitive radios. These technologies hold the potential to fundamentally change the communications landscape. Software-defined radios and cognitive radios enable dynamic spectrum management and dynamic spectrum access networks. These concepts may help provide solutions to the current problem of spectrum scarcity. These sections provide context and motivation regarding research in spectrum measurement. Developments in these areas set the precedent for the development of the KUAR platform and the Spectrum Miner and Spectrum Repository software.

## **Chapter 3 – Proposed Research and Designs**

### ***3.1 Design Requirements and Specifications***

Organizations that wish to monitor spectrum utilization are often constrained by resources, time and personnel. It is often not feasible to have trained staff on hand 24 hours a day for long-term measurement campaigns. In most cases, measurement tests can be defined and then left to an automated system for execution. This automation system optimally contains a graphical user interface so that measurement staff does not have to manually control the data collection equipment or perform any type of custom programming in order to perform measurements. This section articulates the design of a spectrum monitoring and analysis system.

Researchers should be able to define the parameters of a spectrum measurement and then use these definitions in the field to perform multiple measurements. There should be a mechanism for sharing these definitions and recorded data with a variety of organizations engaged in similar research. Additionally, there should be a central repository for spectrum measurement data. This will allow spectrum policy and communications researchers to easily access and study measurement data. Finally, research should be performed regarding construction of distributed spectrum measurement systems using commercial, off the shelf communications equipment or SDR platforms.

### 3.2 *Kansas University Spectrum Utilization Framework*

The Kansas University Spectrum Utilization Framework (KUSUF) is designed to capture, archive, characterize, model and share RF spectrum utilization data. Figure 9 shows the structure of this framework. The Measurement System design specifies a cross-platform software program that can interface with a variety of spectrum collection devices. This program interfaces with a variety of data collection devices, which are typically spectrum analyzers. The program is referred to as the Spectrum Miner spectrum measurement program. The Data Management section defines a persistent data store that is used to manage and archive collected data. The data will also be easily accessible to a variety of analysis programs. The Data Management definition also contains an efficient, archival format that is capable of exporting data to a variety of file formats. Data checksums are calculated for all measurements so that data integrity can be ensured. The Analysis section outlines a workflow between data collection and data analysis software programs. It also discusses methods of sharing data and analysis between researchers. In the final section, a method of using real-world data for modeling, emulation and simulation is outlined.

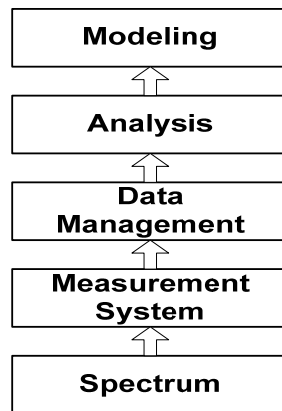

Figure 9 – Kansas University Spectrum Utilization Framework (KUSUF) data flow

### 3.2.1 Spectrum Measurement Workflow

The Measurement System, Data Management and Analysis layers of the KUSUF are implemented using a shared database schema, the Spectrum Miner program, the Spectrum Repository web application and various statistical or mathematical analysis programs (Figure 10). Researchers preemptively enter the settings and parameters that describe a measurement that will be taken during a field measurement campaign. These settings are typically defined in the Spectrum Miner program and stored in a local database. This instance of the Spectrum Miner program can then be used to perform the field measurements or the measurement definition can be transferred to another computer running Spectrum Miner. After the measurement is taken, the spectrum data is stored in the same local database used to store definitions. This data can then be analyzed locally or archived at a central location, the Spectrum Repository, for safekeeping and for sharing with other researchers.

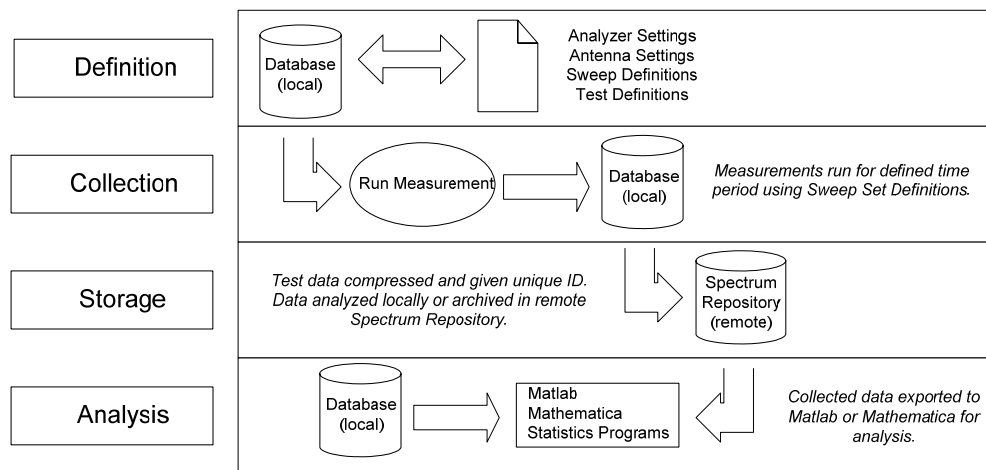
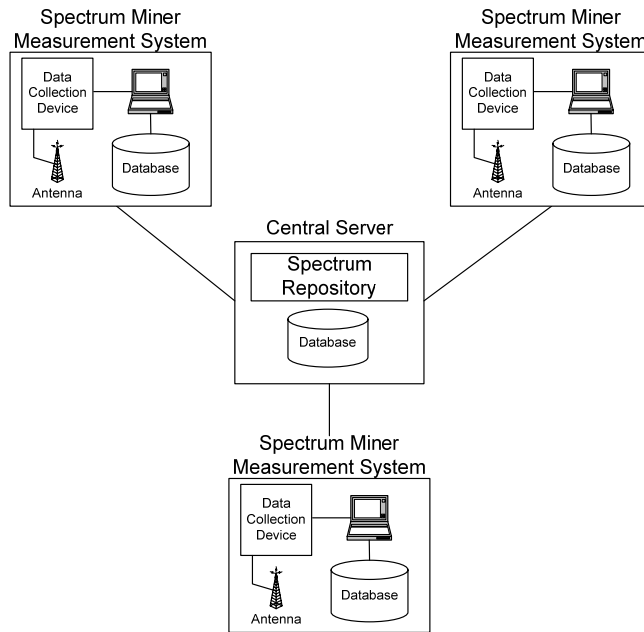

Figure 10 – Spectrum measurement workflow for the KUSUF

### **3.3 *Spectrum Miner design***

The architecture of a distributed data collection system, shown abstractly in Figure 11, is designed to provide automated data collection, archival storage and collaborative analysis. Field collection devices running the Spectrum Miner program are able to synchronize and share measurements with the Spectrum Repository. The Spectrum Miner program can connect to data collection devices, typically spectrum analyzers, through RS-232 serial and General Purpose Interface Bus (GPIB) connections. Data collection can also be performed by the KUAR radio, which transfers measurement data to the Spectrum Miner program through a Secure Shell (SSH) connection. The Spectrum Miner program can perform spectrum measurements using a single data collection device. Multiple instances of the program can also run concurrently to perform parallel or distributed spectrum measurements. Data fusion and storage is coordinated through the Spectrum Repository. This central storage server has a web application interface and supports standard methods of data transfer including FTP and Secure Copy (SCP), allowing a variety of programs to store and archive data in a central location. The central component of the framework is the unified database schema that is implemented in both the Spectrum Miner program and in the Spectrum Repository server. This implementation provides a standardized way for researchers to share experiment descriptions, measurement instances and measurement data. Experiment descriptions are combinations of analyzer and antenna settings that allow tests to be easily replicated. Analyzer settings encompass a start frequency, stop frequency, bin width, attenuation and bandwidth resolution. Antenna settings include the antenna type, center frequency, bandwidth, azimuth, elevation angle and height of the antenna.



**Figure 11 - Distributed layout of the software architecture**

The software design of the Spectrum Miner program aims to automate the process of performing spectrum measurements. The program provides a graphical user interface that makes it easy to define measurements involving multiple antennas, spectrum analyzers and a variety of other variables. This configuration information is then used to take measurements, which involves sweeping the defined section of the spectrum and recording the results. The abstract data collection design allows the software to compensate for differences in data collection devices. For example, the user may specify a resolution bandwidth that is physically impossible on a specific spectrum analyzer. The system will alert the user and suggest a reasonable analyzer parameter value based on the user's initial request. The experiment setup information, the spectrum analyzer or data collection device parameters, and the data are saved as a "measurement definition". After a measurement has been taken, the configuration data and the measured spectrum data are referred to as a "measurement

instance”. Measurement instances also contain other metadata including time, date, GPS coordinates, weather conditions and noise sources. Definitions and instances are designed to be sharable, so that researchers can re-create or peer evaluate these measurements.

Measurement data is initially stored in the local database and can be moved to the Repository or exported in various file formats. The preferred file format is the Spectrum Miner format, which includes checksums to guard against data corruption and data compression to minimize the bandwidth required to share results with the community. A primary goal of the framework is to support data collection from multiple sources and to provide multiple ways to access the data. The Spectrum Miner application is the preferred collection application for the Spectrum Repository, but third party clients are supported through import translators.

### **3.4 *Spectrum Repository design***

The Spectrum Repository is composed of a web application that provides a graphical interface to the central archive database. This interface includes search and filtering functionality to help researchers find measurement data in certain frequency bands or taken within a certain time or date range. Measurements can be downloaded for analysis and simulation usage, or uploaded to share with the research community at large. If researchers have a certain level of authorization, they can also query the central archive database directly. Sharing of regional spectrum data will provide researchers a better understanding of spectrum usage patterns across the country. This application and database will also enable long-term distributed spectrum measurements. Distributed measurement campaigns can be defined as a group of separate research organizations working together to coordinate measurements across a geographic area or as a sensor network deployment of spectrum measurement devices. In



both cases, spectrum measurements can be sent back to the Spectrum Repository which can act as a data fusion node.

To upload information to the database, the user can use the Spectrum Miner program or programmatically perform the following steps:

1. Select one or more measurement instances to upload.
2. Export the corresponding synchronized tables from the local database and upload them to the archive database. This includes the Sweep Set Name, Sweep Set Definitions, Analyzer Settings and Antenna Options tables. These are uploaded and referenced by an assigned organization ID.
3. Intelligently merge the data with the archive database. Measurement instances will be examined to determine if identical analyzer settings or antenna profiles already exist in the archive database. If they exist, measurement and sweep records will be updated to point to those existing database records. If they do not exist, these analyzer and antenna records will be imported into the database.
4. Finally, the measurement instance IDs of records being imported must be checked for uniqueness against those currently in the database. If identical IDs currently exist, new and unique IDs will have to be generated for these measurement instances. These IDs can be checked for uniqueness by querying the database.

### **3.5 Database design**

The Spectrum Miner Database Schema (SMDS) was designed such that data collection devices in the field could easily exchange data with the centralized archive database. The term *local database* refers to the database on a computer running an instance of the Spectrum

Miner program. This database can be queried for reporting purposes or to export data for analysis or storage. The term *archive database* is used to describe the centralized database where measurements are archived for long-term storage. This database typically interfaces with a web application, but other interfaces including sockets, FTP or other data transfer interfaces are possible. The Spectrum Miner program can also query the remote archive database.

### **3.5.1 Database tables**

The SMDS is composed of 8 types of tables that fall into two categories. *Atomic tables* contain data collected in the field that can be placed directly into the Spectrum Repository. *Synchronized tables* contain information that can be shared with other institutions and are merged with existing synchronized tables when atomic tables are added to the archive.

#### **3.5.1.1 Database usage workflow**

The following use cases detail how the unified database schema is used for collecting, storing and archiving spectrum data.

- The person or group that has administrator privileges on the Spectrum Repository database creates an organization ID for each organization that is performing measurements and archiving data.
- An organization or group using the Spectrum Miner software enters their organization ID. The Spectrum Miner application is then capable of downloading records from synchronized tables, including the Organization, Analyzer Settings, Antenna, Sweep Set Name and Sweep Set Definition tables.

- Organizations that wish to replicate specific measurements can use existing sweep set definitions to perform new spectrum measurements. The local analyzer settings table can be modified if the given organization is using a different analyzer or if they wish to change settings specified in the existing sweep set. New antennas can be added or antenna definitions can be modified. All actions will generate unique IDs so that this data will not overwrite existing measurement definitions or data.
- Measurements can be performed by selecting a new or existing sweep set from the Sweep Set Name Table. The measurement data and metadata are stored in records that are located in a local Sweep Set Instance table and one or more Sweep-<GUID> (Globally Unique Identifier) and Measurement-<GUID> tables. A record is generated in the Sweep and Measurement tables each time a Sweep Set is used in a measurement.
- Collected data can be exported in a variety of file formats, including the comma separated value (CSV) format. There is also an option to generate Matlab – MySQL connector queries that can import data directly from the local MySQL database into a Matlab workspace.
- To facilitate data sharing, organizations can use the Data Export interface in the Spectrum Miner program to select specific data sets. These data sets and their metadata can be compressed using the Archive Data File Format and then either archived in the Spectrum Repository or sent directly to another organization. These compressed files contain Sweep Set Name, Sweep Set Definition and Sweep Set Instance tables, along with the corresponding Sweep, Measurement, Antenna Definitions and Analyzer Settings tables.

- When one or more measurements are selected to be uploaded to the Spectrum Repository, the measurement's respective records are selected from the Sweep Set Name, Sweep Set Definition, Antenna, Analyzer Settings and Sweep Set Instance tables. These records are imported into the archive database under identical table names. New record IDs are generated if duplicate IDs are detected between the records being imported and existing archive records.
- Measurement Data from the Spectrum Repository can also be exported to a local database. The same Archive Data File Format used to send data from a local device to the Spectrum Repository is used when data is downloaded from the archive database.

### 3.5.1.2 Relational structure of Synchronized and Atomic tables

Comment [I1]: Redo this table? Put with permission from TW?

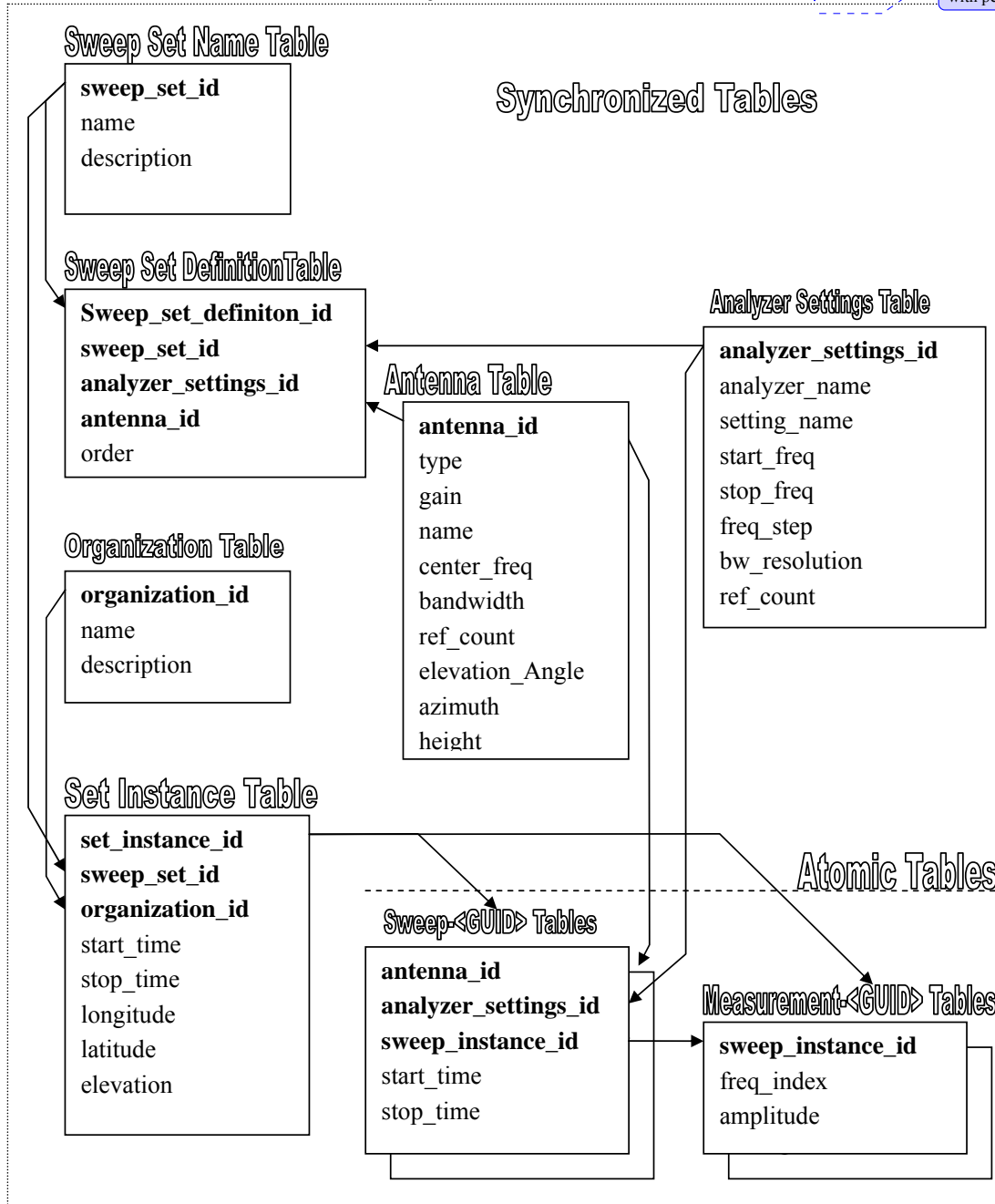

Figure 12 – Relational structure of synchronized and atomic tables in the database [53]

### 3.5.1.3 Synchronized tables

Synchronized tables allow unique database IDs to persist across multiple instances of the Spectrum Miner program. This allows researchers to share measurement definitions and easily replicate published measurements. Measurements are transferred by uploading records from the atomic and synchronized tables. Synchronized records from the local database are compared with records in the archive database and then merged. Duplicate row discovery is accomplished by creating a unique ID from a hash of data contained in that row. These duplicate rows are thus assigned a new, unique ID and merged with the records in the archive synchronized tables. This prevents organizations from overwriting existing measurements or creating duplicate entries. Each table can have more than one key, but only one primary key. When a column in a table is selected as a key in MySQL, the database makes internal optimizations to improve the performance of searches indexed by a given key.

**Table 2 – Synchronized tables**

<b>Table Name</b>	<b>Description</b>
Sweep Set Name	A name and ID that links a group of sweeps, creating a set of sweeps that can be run during a measurement.
Sweep Set Definition	Holds setting definitions for each sweep, as well as the order of sweeps in a sweep set
Sweep Set Instance	Stores information collected when a sweep set is used to execute a spectrum measurement. Includes antenna location and direction. Generates a unique ID hashed on the data, which is used as part of the unique ID for the Measurement and Sweep tables.
Organization	IDs of organizations taking and sharing spectrum measurements
Analyzer Settings	Parameters defining the use of a data collection device, typically a spectrum analyzer
Antenna	Defines parameters of antennas used during measurements

### 3.5.1.3.1 *Sweep Set Name table*

This table contains a Sweep Set ID, which is used to group Sweep Set Definitions and Sweep Set Instances. The Spectrum Miner uses this table to give the user a list of Sweep Sets to use for performing spectrum measurements.

**Table 3 – Sweep Set Name table definition**

Column Name	Type	Description
sweep_set_id	Char(32) unique not null primary key	Sweep Set table ID
name	Char(50) not null	Name of the sweep set.
description	Mediumtext	Textual description of the sweep set.

**Keys:**

Sweep\_set\_id - globally unique ID for each unique sweep set, primary key for Sweep Set Name table

### 3.5.1.3.2 *Sweep Set Definition table*

Before taking a measurement, a researcher creates a Sweep Set Definition. This definition is composed of sweeps. Individual sweeps contain a bounded frequency span and various other spectrum analyzer settings. A sweep set is a collection of these sweeps in a specific order. For example, a sweep set could be configured to sweep both the FM and TV bands. In this case, the first sweep would span from 88 – 108 MHz with certain specified parameters such as bin width and resolution bandwidth. The second sweep would span 54 – 806 MHz with specific bin width and resolution bandwidth values. These Definitions can be used to perform spectrum measurements, in much the same way that a recipe provides ingredients and instructions for cooking a meal. Once a measurement has been taken, the spectrum data and

its associated metadata, in this case the spectrum analyzer settings used in the measurement, are stored as a Sweep Set Instance.

Sweep set definitions can be used to repeatedly execute measurements at different times throughout the day, different days of the week, different geographic locations or with various antenna configurations. Sweep sets can be comprised of contiguous or non-contiguous bands of spectrum. Linking multiple sweeps to the same ID in the Sweep Set Name table forms Sweep Sets. Each sweep in this table has associated metadata, including analyzer settings, antenna options, and order in the sweep set. The order is the ordinal position of the sweeps in a set, organized from smallest to largest value.

**Table 4 – Sweep Set Definition table definition**

<b>Column Name</b>	<b>Type</b>	<b>Description</b>
sweep_set_definition_id	Int not null primary key	Unique ID identifying a sweep.
sweep_set_id	Char(32) not null	Links to a sweep set defined in Sweep Set Name table.
analyzer_settings_id	Char(32) not null	Links to the analyzer parameters for this sweep stored in the analyzer settings table
antenna_id	Char(32) not null	Links to the antenna options for this sweep stored in the antenna table
order	Smallint unsigned not null	The ordinal position of the sweep in the associated sweep set

**Keys:**

sweep\_set\_definition\_id – unique ID for sweep definition, primary key for Sweep Set Definition table



sweep\_set\_id – links to the sweep\_set\_id from the Sweep Set Name table; used to group sweeps into a named sweep set.

analyzer\_settings\_id - links to a specific analyzer setting in the Analyzer Settings table.

antenna\_id – links to specific antenna options in the Antenna table.

### 3.5.1.3.3 *Organization table*

This table contains an organization ID that is assigned by the party or parties with administrative rights to the Spectrum Repository archive database. This unique ID is also used in the Sweep-<GUID> tables to identify the organization that produced a specific measurement. Name and description fields are also available for each organization.

**Table 5 – Organization table definition**

<b>Column Name</b>	<b>Type</b>	<b>Description</b>
organization_id	Int unsigned not null primary key	Unique organization ID, used to identify measurement sweeps
name	Varchar(50) not null	Name of the organization
description	Mediumtext	Description of the organization

**Keys:**

organization\_id – A primary key assigned for the purpose of referencing the organization.

### 3.5.1.3.4 *Analyzer Settings table*

Both Sweep Set Definitions and Sweep Set Instances link to Analyzer Settings. The records in this table store the spectrum analyzer settings that are used in definitions and measurement instances. To ensure uniqueness, the analyzer settings ID is generated using an MD5sum hash

of a row's attenuation, start frequency, stop frequency, bandwidth resolution and frequency step values. These values are written as strings with vertical pipes (|) separating the values and then passed to the hashing algorithm. Duplicate hash values are accepted if both fields contain identical data. This duplication is acceptable as it is possible for multiple tests to use identical analyzer settings.

Analyzer settings are defined for a sweep. The setting is given a name, typically the communications band to be swept on the analyzer. The start frequency is the lower edge of the frequency span under measurement and must be less than the stop frequency. The stop frequency is the upper limit of the frequency span. Using a double data type for these database values allows for sub-Hz resolution. The granularity of measurement between the start and stop frequencies is defined by the frequency step. Spectrum amplitude measurements are taken at frequencies:

**Equation 1 – Step frequency equation (general spectrum analyzers)**

$$Freq(n) = start\_freq + bin\_width * freq\_index(n)$$

Where bin\_width is an integer ranging from 0 to n, with n representing the frequency step in MHz

The frequency step and bin width variables are slightly different when the KUAR is used as a spectrum analyzer. These variables depend on the size of the FFT used in the FPGA to generate frequency domain samples and the sampling frequency of the ADC (80 MHz on the version 2.0 digital board). It should be noted that the KUAR step frequency equation reduces down to the same equation as Equation 1. The step frequency equation for the KUAR is:

**Equation 2 – Step frequency equation (KUAR)**

$$Freq(n) = start\_freq + \frac{samp\_freq}{FFT\ size} * freq\_index(n)$$

Attenuation and bandwidth resolution values are also stored in this table. The spectrum analyzer deals with high dynamic range signals by setting internal attenuators using values stored in the database. Bandwidth resolution determines the smallest frequency that can be resolved by the spectrum analyzer. In digital spectrum analyzers, this equates to the FFT bin size. Resolution bandwidth is integrally linked with other spectrum analyzer parameters, including sweep time, span and video bandwidth. A smaller resolution bandwidth will have a larger sweep time. The signals or band being measured has a direct impact on whether the user will attempt to optimize the measurement's sweep time or bandwidth resolution. Bandwidth resolution relates physically to the shape of the IF filter in the analyzer, along with its 3 db bandwidth. According the HP 8590 Spectrum Analyzer Users Guide [64]:

“The shape of the filter is defined by the shape factor, which is the ratio of the 60 dB bandwidth to the 3 dB bandwidth. (Generally, the IF filters in this spectrum analyzer have shape factors of 15:1 or less.) If a small signal is too close to a larger signal, the skirt of the larger signal can hide the smaller signal. To view the smaller signal, you must select a resolution bandwidth such that k is less than a.

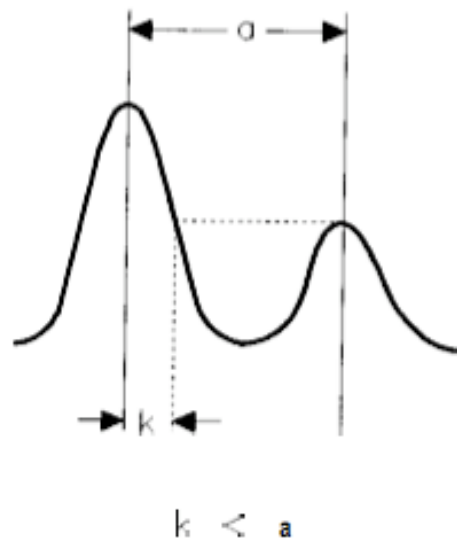

**Figure 13 – Resolution bandwidth requirements for resolving small signals on an HP 8590 spectrum analyzer (copyright HP / Agilent Labs) [64]**

The separation between the two signals must be greater than half the filter width of the larger signal at the amplitude level of the smaller signal.”

The reference count field keeps track of the number of sweep instances that use a specific analyzer setting. If a user deletes a measurement instance in the Spectrum Miner program, the program will not remove an analyzer setting record if it is referenced by other sweeps.

**Table 6 – Analyzer Settings table definition**

Column Name	Type	Description
analyzer_settings_id	Char(32) not null primary key	Globally unique ID used by sweeps to identify the analyzer settings used by measurement definitions or instances

<b>Column Name</b>	<b>Type</b>	<b>Description</b>
setting_name	Char(50) not null	The name of the analyzer setting; typically refers to a specific spectrum band.
start_freq	Double not null	The lowest frequency in the span under measurement. Units in Hz.
stop_freq	Double not null	The highest frequency in the span under measurement. Units in Hz.
freq_step	Char(100)	The frequency range between measurements that sub-divide the span defined by the start and stop frequency. Units in Hz.
bw_resolution	Double not null	The bandwidth resolution in Hz to be used for 'LINEAR' analyzer settings, freq_step.
attenuation	Double	Attenuation settings for the analyzer. Units in dB.
ref_count	Int unsigned not null	Reference counter tracks the number of sweep sets that refer to a particular analyzer setting.

**Keys:**

Analyzer\_settings\_id – unique ID for a specific analyzer setting

**3.5.1.3.5 Antenna table**

Information related to the antennas used for spectrum measurements is stored in this table.

Antenna IDs are globally unique and are generated using an MD5sum hash of the given rows gain, center frequency, bandwidth, azimuth, elevation angle and height fields. The values are appended to a character string, with a vertical pipe ( | ) separating each field value. This concatenated string is then passed to the hashing algorithm and a unique ID is generated.

Duplicate hash values are accepted if both fields are checked and contain identical data. This duplication is acceptable as it is possible for multiple tests to use identical antenna options.

Antenna gain is not applied directly to spectrum measurement data. Programs like Spectrum Miner can retrieve the antenna gain values used for a set of measurements and apply the antenna gain values during post-processing. Additionally, the center frequency of the 3 dB frequency response bandwidth of the antenna is used by programs like Spectrum Miner as a sanity check to ensure that values measured using a specific antenna are actually within the capabilities of that antenna's specifications. If these fields are left empty, programs that use the database schema will not perform a sanity check.

**Table 7 – Antenna table definition**

<b>Column Name</b>	<b>Type</b>	<b>Description</b>
antenna_id	Char(32) unique not null primary key	Unique ID used to identify antennas used in the sweep tables.
type	Char(50) not null	Antenna type (dipole, omnidirectional, yagi, etc.)
gain	Float not null	The gain of the antenna in dB.
name	Char(50)	Allows users to differentiate between antenna settings that use the same physical antenna, but different parameters per measurement (i.e. different heights, elevation angles, etc.)
center_freq	Double	The frequency in the middle of the antenna bandwidth in Hz.
bandwidth	Double	The 3dB bandwidth of the antenna in Hz.
azimuth	Smallint	The azimuth angle of the antenna. Units in 1/100 degree from 0 to 35999.
elevation_angle	Smallint	The elevation angle of the antenna. Units in 1/100 degree from 0 to 9000.
height	Smallint unsigned	The distance from the ground to the antenna. Units in meters.

Column Name	Type	Description
ref_count	Unsigned int not null	Reference counter tracks the number of sweep sets that refer to a particular antenna.

**Keys:**

Antenna\_id – globally unique ID that identifies an antenna, prevents unnecessary duplicate entries in the database

**3.5.1.3.6 Sweep Set Instance table**

As discussed above, researchers can create a Sweep Set Definition that defines all of the parameters that will be used during a spectrum measurement. When a measurement is taken, its configuration metadata is recorded. This specific information includes the start and stop times of the measurement, the longitude, latitude and elevation of the location where the measurement was performed, and the ID of the organization performing the measurement. Sweep Sets can contain multiple antennas and spectrum analyzer settings (on a per sweep level), thus they are stored in the Sweep-<GUID> table. Sweep Set Instance record values cannot be changed after a measurement is performed to preserve the integrity of measurement metadata.

Sweep Set Instance IDs must be globally unique or else measurements could be over-written in the database. To create a unique ID, the program interfacing with the database will perform an MD5sum of the current time and a random number. This process will be repeated until a new and unique ID is found.

There could potentially be many Sweep Set Instances if numerous measurements are stored in either the local or archive database. To calculate disk usage, it should be noted that each row in the Sweep Set Instance table requires 84 bytes of storage (in the current MySQL implementation).

**Table 8 – Sweep Set Instance table definition**

<b>Column Name</b>	<b>Type</b>	<b>Description</b>
set_instance_id	Char(32) unique not null	Unique ID for a sweep set that has been used to take a measurement
sweep_set_id	Char(32)	Links to the Sweep Set Definition used to take this measurement
start_time	Datetime not null	Start time and date of the measurement.
stop_time	Datetime not null	Stop time and date of the measurement.
longitude	Int signed	The longitude of the location of the antenna. Units are 1e-6 degrees.
latitude	Int signed	The latitude of the location of the antenna. Units are 1e-6 degrees.
elevation	Int signed	The elevation above mean sea level in 1/100 of meters.
organization_id	Int unsigned	An organization_id from the organization table.

**Keys:**

Set\_instance\_id – Uniquely identifies a specific Sweep Set Instance.

Sweep\_set\_id – many to one link to sweeps in the Sweep Set Table (i.e. multiple instances can link to a single Sweep Set Definition)



### **3.5.1.4 Atomic tables**

Atomic tables contain data that is specific to individual measurements and thus can be uploaded without modification to the archive server. Synchronized tables link to data within atomic tables, thus both types of tables are uploaded to the Spectrum Repository when measurements are being archived. In the rare case that duplicate IDs are found in an atomic table, they will be dealt with automatically by the Spectrum Miner program or by the Spectrum Repository server. The `set_instance_id` generated from an MD5sum hash in the Sweep Set Instance table is used as a suffix to provide globally unique IDs for the Measurement and Sweep tables. In these two tables, unique IDs take the form of Measurement-<GUID> or Sweep-<GUID>.

#### ***3.5.1.4.1 Measurement-<GUID> tables***

This table holds the amplitude values collected while performing a spectrum measurement. Each time a Sweep Set Definition is executed (i.e. multiple measurements with the same settings), a new Measurement record is created. The `sweep_instance_id` is implemented using an unsigned long int, thus allowing an upper limit of roughly 4.3 billion sweeps in the Measurement table. The frequency index is also implemented as an unsigned long int, meaning that roughly 4.3 billion amplitude values can be stored per sweep.

To minimize the amount of data that must be stored, frequencies are stored as a frequency index and contain a link to a frequency step value. This allows the range of frequencies contained in a sweep to be stored with much lower precision. If the database schema had used double real or big int values (8 bytes), the size of the table would increase by over 40% (10

bytes vs. 14 bytes). The Spectrum Miner program or an associated data analysis program can easily recreate the exact frequencies with their corresponding units using the frequency step equations listed above.

Amplitude values are stored uncorrected after they are received from the data collection device. Values like antenna gain or various calibration factors are stored such that these correction factors can be applied at a later date. The amplitude column uses a signed small int data type (2 bytes). The units used for amplitude values are 1/100 dBm. Thus the total range provided by this data type is -327.68 dBm to 327.67 dBm. In practice, this is a much greater range than what actual equipment is capable of providing. Measurement tables use more disk space than all of the other tables. Each Measurement table rows require ten bytes of storage.

**Table 9 – Measurement-<GUID> table definition**

<b>Column Name</b>	<b>Type</b>	<b>Description</b>
sweep_instance_id	Int unsigned not null	Based on sweep_instance_id in Sweep Set Instance table.
freq_index	Int unsigned not null	A frequency index.
amplitude	Smallint	Amplitude units are 1/100 dBm.

#### **3.5.1.4.2 Sweep-<GUID> tables**

Each sweep that has been executed during a spectrum measurement has a variety of metadata, including an antenna, analyzer settings, start time and stop time. Each unique Sweep-<GUID> record is linked to a corresponding Measurement-<GUID> record. Each row of the Sweep table requires 86 bytes, 70 of which are taken up by database keys.

**Table 10 – Sweep-<GUID> table definition**

<b>Column Name</b>	<b>Type</b>	<b>Description</b>
sweep_instance_id	Int unsigned not null unique	Uses sweep_instance_id in Sweep Set Instance table. Used to link Sweep-<GUID> records with Measurement-<GUID> records.
antenna_id	Char(32) not null	Antenna ID from the Sweep Set Instance
analyzer_settings_id	Char(32) not null	Analyzer Settings ID from the Sweep Set Instance
start_time	Datetime not null	Start time and date of the individual sweep.
stop_time	Datetime not null	Stop time and date of the individual sweep.

**Keys:**

Sweep\_instance\_id – Primary key, links specific sweeps to a measurement.

Antenna\_id – links antennas in a sweep to the antenna recorded in a Sweep Set Instance

Analyzer\_settings\_id – links analyzer settings in a sweep to the analyzer settings recorded in a Sweep Set Instance.

### **3.6 Database Archival Import / Export Formats**

There are two types of archival file formats that can be used to import or export data from the local and archive databases. Both formats use data compression to save disk space and network bandwidth. They also use MD5 checksums to ensure data integrity. The Spectrum Miner Archive Format (SMAF) uses checksums, compression and stores the data in comma separated value (CSV) files. The General Export Format (GEF) is a standard comma separated value (CSV) file that can be parsed by a variety of third-party programs.

### **3.6.1 Spectrum Miner Archive Format**

This format places a signature file and the compressed data inside a compressed file. The signature file contains the version number of the database schema, Spectrum Miner and MySQL database being used as well as an MD5 checksum of the data files. The tables containing metadata about the measurement are also stored in the compressed file as CSV files.

### **3.6.2 General Export Format**

The CSV format allows almost any third-party program to import spectrum data. This format does not include any checksums or compression. Third-party spectrum measurement programs can also generate data in this format and then seamlessly upload it to the Spectrum Repository.

## ***3.7 Database Storage Requirements***

The database schema was designed to be able to support distributed spectrum measurements taken across a metropolitan area. Data types were selected to support billions of spectrum measurements. To estimate storage requirements, the following scenario was considered:

The HP 8594E spectrum analyzer produces 401 amplitude values per sweep of a specified frequency span. A common bandwidth resolution of 10 kHz is selected. A sweep of common communications bands is configured, ranging from 400 MHz to 2.5 GHz. This frequency span of approximately 2.1 GHz contains 210,000 bins (2.1 GHz / 10 kHz). The number of sweeps required to cover this number of bins is 525 (210,000 / 400 bins per sweep). It has

been found experimentally that a sweep of 401 points at 10 kHz spacing takes roughly 4 seconds. It thus takes approximately 2100 seconds or 35 minutes (525 sweeps \* 4 seconds sweep time per bin) to scan and measure 2.1 GHz of bandwidth. In a 24 hour period, this spectrum can be measured approximately 41 times if measurements are run continuously. Thus the total number of measurements that must be stored for a single data collection device over a 24 hour period is in this scenario 8,610,000.

It can be seen from this scenario that measurement campaigns that last multiple days and include multiple analyzers can easily generate billions of measurements. These figures can help provide estimates of the data storage space required to hold these types of measurements.

### **3.7.1 Disk space estimation**

As discussed previously, the Measurement-<GUID> tables are the dominant tables with respect to data storage space. MySQL stores each table as two files: a raw data file and a table keys file. The disk space required for 24 hours of measurement data is 8.61 million measurements times 10 bytes per measurement, which equals 82.1 megabytes. The database table keys for the Measurement tables generated during this time also take up 6 bytes per unique bin \* 210,000 bins (see example hypothetical measurement scenario in section 3.7), which is roughly 1.2 megabytes. The Sweep tables require 84 bytes per sweep and a 24 hour measurement campaign produces 41 measurements per day with 525 sweeps per span. Thus the space required for the Sweep tables for 24 hours of data is 84 bytes times 525 sweeps times 41 measurements, or roughly 1.7 megabytes.

It is important to remember that these values are for one analyzer with one antenna configuration. If multiple antennas with different polarizations or directional orientations are connected to multiple analyzers, and this configuration is replicated throughout a city, the data requirements will grow rapidly. The storage figures presented here are based on a hypothetical measurement campaign, but they illustrate the possible data storage requirements of the shared schema database.

## Chapter 4 – Implementation

### 4.1 *Spectrum Miner*

The Spectrum Miner program is a software application developed at the Information Telecommunications and Technology Center (ITTC) at the University of Kansas. It automates the process of taking spectrum measurements using a spectrum analyzer or software-defined radio. It is written in Java, allowing it to be run on a variety of operating systems and computing platforms. The program uses a MySQL relational database for data storage. It contains an easily extendable communications protocol, with RS-232, GPIB and SSH connections currently implemented. The first two connections are physical data interfaces used when a computer is connected directly to a data collection device such as a spectrum analyzer. The SSH connection is used to connect to a software-defined radio, in this case a KUAR radio, across a network. The Spectrum Miner program configures the KUAR to act as a simple spectrum analyzer. An analyzer abstraction layer allows support for new analyzers to be easily added. The ability to control multiple analyzers in a single instance of the program will be added in the future. Support for the HP 8594E and IFR 2398 spectrum analyzers and the KUAR spectrum analyzer radio configuration have been implemented.

The Spectrum Miner program allows the user to run numerous sweeps over given sections of the spectrum and then record the measurements in a local database. Data collection device settings are configurable through the program. The application also records metadata such as antenna settings, GPS coordinates and time of sweep. The program can backup measurement data locally or upload it to the Spectrum Repository. Spectrum Miner can also export data in a compressed or CSV format. The database schema used by Spectrum Miner and Spectrum

Repository has been designed to accommodate extremely large datasets generated by long term measurement campaigns.

#### **4.1.1 Measurement / Data Collection**

The process of taking measurements is abstracted in the Spectrum Miner program. The program allows a user to connect to and control a variety of data collection devices without having to know their specific operating parameters. The specific hardware details of each analyzer device must be known and implemented in such a manner that the program will prevent the user from improperly configuring the analyzer. This could cause the analyzer to enter a bad state and generate invalid results. Many of the parameters used in the Analyzer Settings dialog map directly back to hardware settings in the analyzer. For example, resolution bandwidth settings are controlled in the analyzer by switching between several analog filter banks. There are also a limited number of specific attenuation values that are acceptable for use. Spectrum analyzers typically return data in a trace array that has a fixed number of points. When given a frequency span, the analyzer will sweep across the span and average the power measurements. A trace, which is an array of amplitude values, is returned to the computer. This trace array is a fixed size and is specific to each spectrum analyzer device.



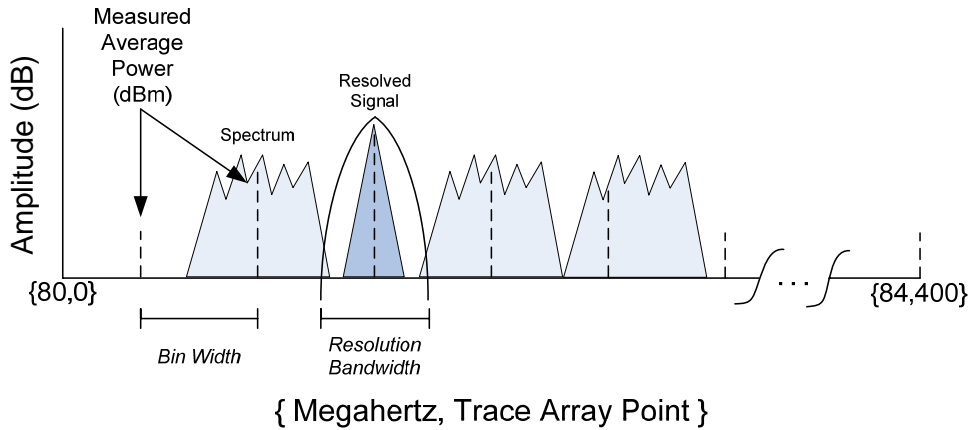
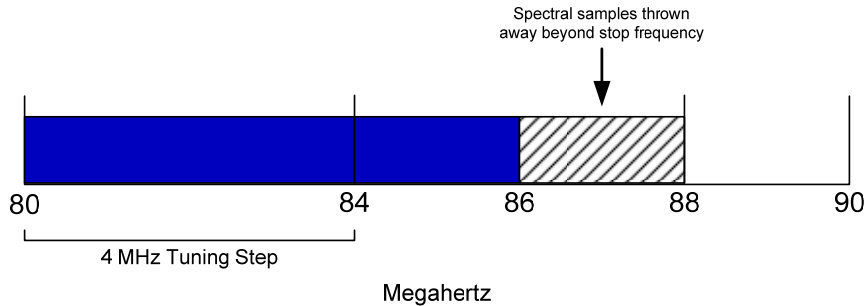

**Figure 14 – Discrete measurements of spectrum bound by bandwidth resolution and bin width**

The Spectrum Miner software can divide certain frequency spans into “virtual sweeps”. These sweeps are physically possible on the analyzer, but are sub-divided to maintain certain bin width or resolution bandwidth settings. The sweeps are divided into separate physical sweeps on the analyzer and then re-combined into one physical sweep in software (Figure 15). In the KUAR, the Analyzer Settings are translated into control commands for the RF Board of the KUAR. The microcontroller on the RF Board then configures the necessary analog RF components to tune to the requested frequency range. This section highlights implementation details related to specific hardware parameters of the various data collection devices used to perform spectrum measurements.

The Spectrum Miner program will configure the data collection device to match the requested sweep parameters while staying within the capabilities of the device. For example, the Phased Lock Loops (PLL) on the KUAR RF Board can only tune in 4 MHz increments. If the user requests a sweep over a frequency span that is not a multiple of four, the program will request

additional sweeps to cover the remaining frequencies in the span. This example is highlighted in Figure 15, where two sweeps are required to cover the frequency span of 80 MHz to 86 MHz. When the requested bandwidth has been scanned, the software will discard any received spectral samples beyond the stop frequency. Hardware spectrum analyzers also have to perform multiple sweeps across a span based on the user-specified resolution bandwidth and bin width.



**Figure 15 – Multiple analyzer sweeps required to cover a band; unnecessary samples discarded**

#### **4.1.1.1 *HP 8594E spectrum analyzer***

The HP 8594E spectrum analyzer can perform spectrum measurements ranging from 9 kHz to 2.9 GHz. The 8594E has both serial and GPIB connections allowing it to interface with a computer. Spectrum analyzers that can connect to a computer typically have a basic command driven control language [65]. This language allows the spectrum analyzer to be programmatically controlled and return data to the computer.

**Table 11 – HP 8594E analyzer specific parameters**

<b>Hardware Parameter</b>	<b>Value(s)</b>
Discrete points per trace / sweep	401
Analyzer trace values per dB	3600
Attenuation settings	{0, 10, 30, 40, 50} dB
Resolution Bandwidth settings	{1, 3, 10, 30, 100, 300} kHz, {1, 3} MHz
Trace vertical size	80 dB

**4.1.1.2 IFR 2398 spectrum analyzer**

The IFR 2398 spectrum analyzer is capable of measuring spectrum ranging from 9 kHz to 2.7 GHz. Like the HP8594E, it has both serial and GPIB connections. It also features a command driven control language.

**Table 12 – IFR 2398 analyzer specific parameters**

<b>Hardware Parameter</b>	<b>Value(s)</b>
Discrete points per trace / sweep	500
Analyzer trace values per dB	3600
Attenuation settings	{0, 10, 20, 30, 40, 50} dB
Resolution Bandwidth settings	{1, 3, 10, 30, 100, 300} kHz, {1, 3} MHz
Trace vertical size	80 dB

**4.1.1.3 KUAR spectrum analyzer radio configuration**

The KUAR can be used as a simple, yet highly frequency agile and reconfigurable spectrum analyzer. This section describes the control and data flow paths that were implemented to allow the Spectrum Miner program to use the KUAR as a spectrum analyzer (Figure 17).

The KUAR RF Board provides 40 MHz of baseband bandwidth (left half of Figure 8). The usable or effective bandwidth is actually 30 MHz however due to analog filtering on the RF Board. This 30 MHz is selectable in 4 MHz tuning steps. There is also a known issue in the RF board where consistent quadrature phase and amplitude issues result in inaccurate spectral samples beyond +/- 8 MHz at baseband. For this reason, the KUAR spectrum analyzer configuration uses +/- 4 MHz of bandwidth (8 MHz effective) at baseband, despite having 30 MHz effective bandwidth (Figure 16).

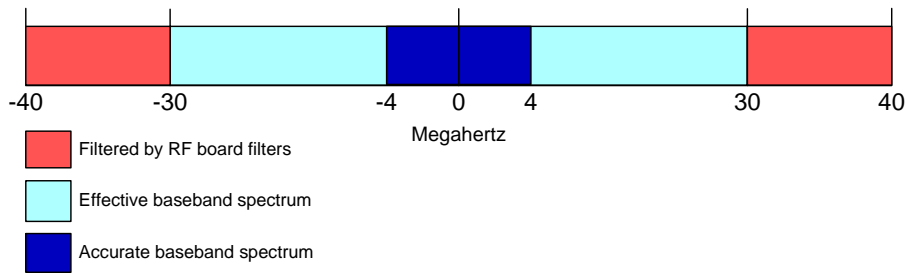

**Figure 16 – Total, effective and usable KUAR RF baseband bandwidth**

In the Settings section of the Spectrum Miner program, the Analyzer Com Port drop-down box provides a list of KUAR radios that are available on the local network. Various networking techniques, such as VPN configurations, can be used to provide access to remote KUARs. After selecting a KUAR as the data collection device in the Settings menu, a user

may begin running a measurement. The Spectrum Miner program uses a Java library from the KUAR Control Panel software to connect to the radio through a SSH connection.

Spectrum Miner uses a secure shell connection is used to start an instance of the FPGACnfg program running under Linux on the KUAR (Figure 17 – Spectrum Miner to KUAR control and data flowFigure 17). This program is used to flash the FPGA with a bit-file that contains reconfigurable hardware designed to sample and process the spectrum. The Spectrum Miner program then makes a call to the rfControl program on the KUAR. The frequency span and bin width parameters are sent to the CPH of the KUAR. They are then transmitted over an I2C to a microcontroller on the RF Board. The microcontroller interprets the parameters and configures the PLLs and other RF components to tune to the specified frequency range. At this point, the Spectrum Miner program uses the fpgaRW program to set a bit in the control register of the digital sampler that has been created in the FPGA. This control bit instructs the digital sampler to read data from the ADC on the Digital Board. The spectrum samples are then fed to an 8192 point FFT. The size of the FFT can be configured in the VHDL code for the reconfigurable hardware and other FFT sizes can be easily generated. In the future, a variety of bit files with various FFT sizes will be made available so that Spectrum Miner can select the FFT size as a parameter in the Settings pane. After the FFT, the samples are stored in a hardware FIFO in the FPGA. Spectrum Miner uses FPGARW again to read from memory locations defined in Linux that are mapped across a hardware memory bus to registers in the FPGA. This register interface is implemented in the FPGA using the KUAR Memory Interface, a VHDL module available in the KUAR design library. These registers are connected to the sampler FIFOs, such that reading from a mapped memory address transfers the samples from hardware to software. The samples are then

transferred across the network back to the Spectrum Miner program and stored in the local database. The program then calls the rfControl program again, configures the RF Board for the next sweep and repeats the process detailed above until the measurement is complete.

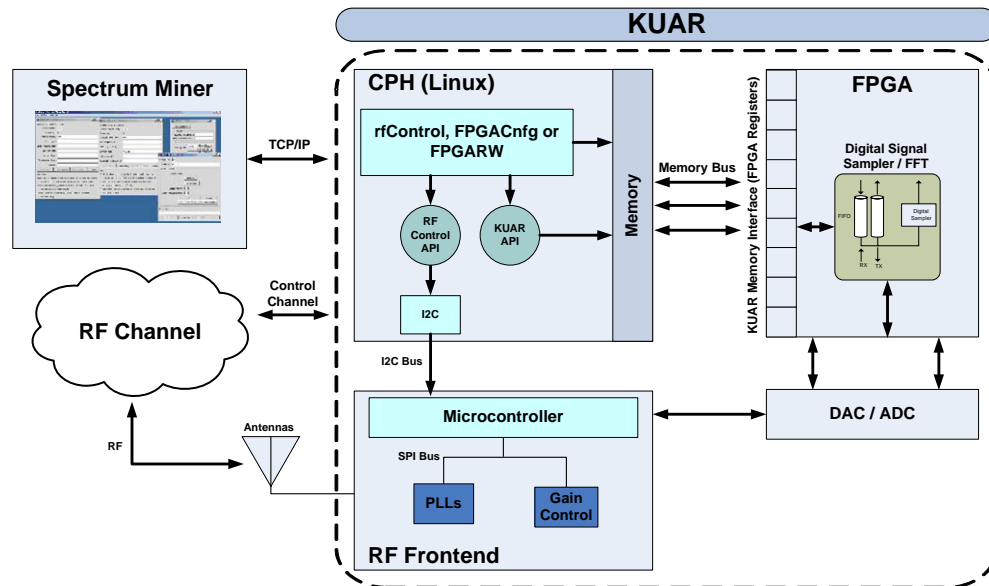
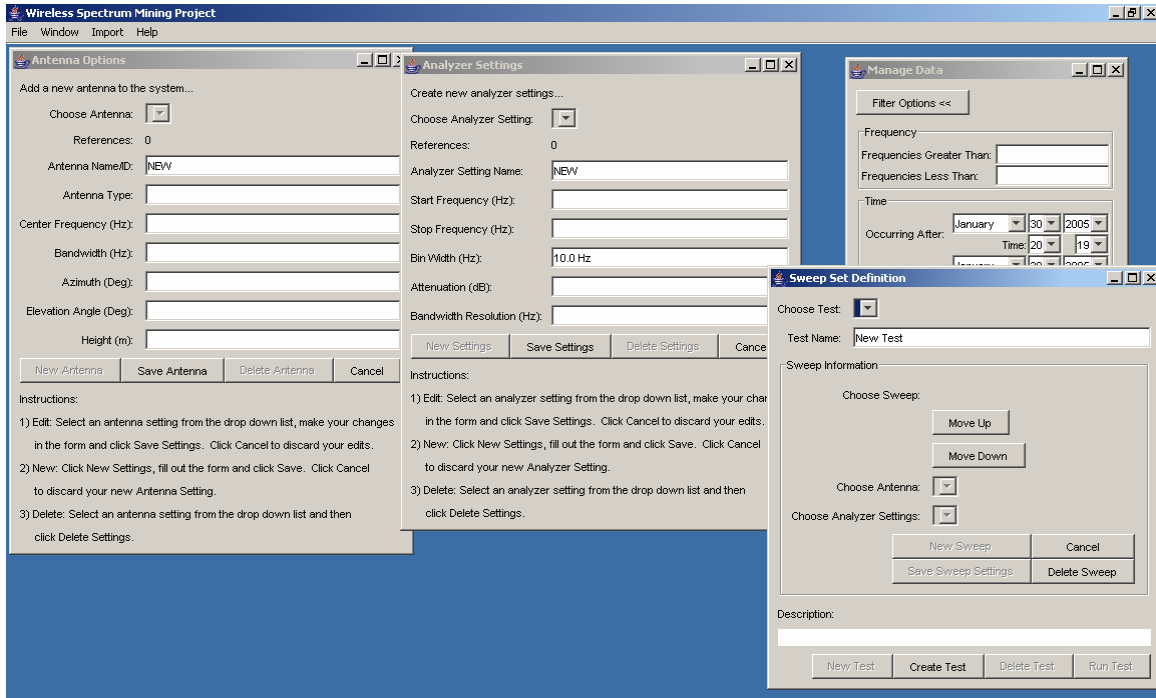

Figure 17 – Spectrum Miner to KUAR control and data flow

#### 4.1.2 Program Layout and Usage

The Spectrum Miner program uses a Multiple Document Interface (MDI) with individual frames or windows that allow the user to specify settings for Sweep Sets, Analyzer Settings, Antenna Options and Data Management (Figure 18). These frames provide standard create, read, update and delete interfaces to the settings and measurement data.

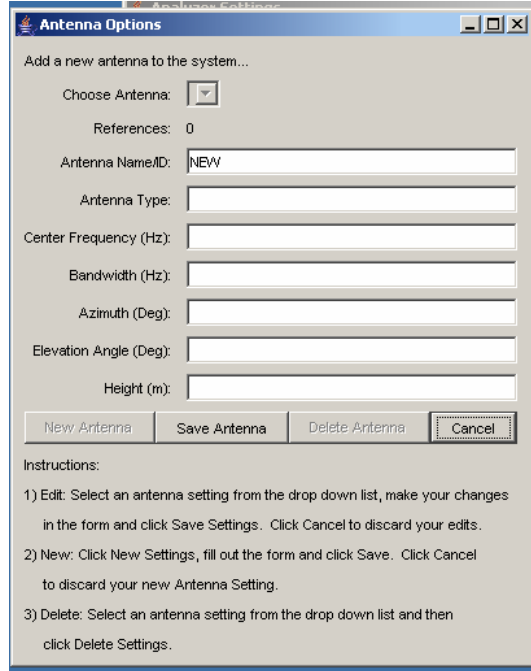

**Figure 18 – Spectrum Miner program**

The Spectrum Miner program allows users to set the parameters of a measurement, execute that measurement in an automated fashion, export the results and archive the data.

**4.1.2.1 Define antenna options**

To define an antenna, the user selects the Antenna Options window (Figure 19). Antennas are identified by their user-assigned name and their type. Other antenna-specific parameters include the antenna’s center frequency and 3 dB bandwidth, both in Hertz. An antenna can have parameters that are specific to a certain measurement campaign or instance. The azimuth, elevation angle and height are specific to how the antenna is oriented and deployed in the field.



**Figure 19 - Antenna Options window**

The antenna window, like all other windows in the Spectrum Miner program, performs error checking based on the values that a user enters. For example, the window checks that the correct units were entered for a given field. Fields that are left blank are automatically filled with default values. If the user creates an antenna profile that is identical to an existing profile, an alert will be generated and the user will be advised to change the configuration or use the existing profile.

New antenna profiles can be created by entering a name and unique antenna parameters and then clicking the “Save Antenna”. A blank antenna profile can be created by clicking on the



“New Antenna” button. Existing antenna profiles can be viewed, edited or deleted by selecting an antenna profile name from the drop down box. Antenna profiles can be edited or deleted as long as they have not been referenced by a sweep set instance in the database. The window displays a reference count to let the user know how many times this profile has been used for performing measurements. Antenna profiles may only be deleted if all the sweep set instances that reference the profile are deleted as well.

#### **4.1.2.2 Define Analyzer Settings**

Analyzer settings include a setting name, start frequency, stop frequency, bin width, attenuation and bandwidth resolution (Figure 20). The start and stop frequency fields define the span of spectrum to be measured. Spectrum analyzers typically take measurements of a particular band and return an array of power spectrum density values. Spectrum analyzers face a constant tradeoff between sweep time and resolution bandwidth. To allow large bands to be scanned with small resolution bandwidths, the user is allowed the ability to define a bin size. The bin size parameter allows the user to specify the frequency spacing between discrete measurements (see Equation 1). Resolution bandwidth determines the smallest signals that can be resolved in the band currently being measured. Using these two parameters, sweeps can be defined that would not be possible on certain physical spectrum analyzers. Sweeps over large frequency spans are broken up into smaller virtual sweeps that maintain the user-desired bin width and resolution bandwidth. These multiple virtual sweeps are then combined into one sweep and stored in the database.

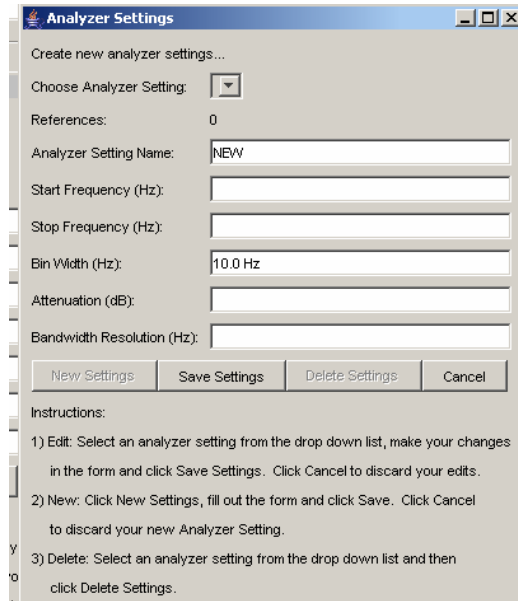

**Figure 20 - Analyzer Settings window**

Analyzer setting creation, editing and deletion are handled in a manner similar to the Antenna Options window. Unit checking and validation is performed immediately after a user enters a value. The frequency span is checked and illegal ranges or improper units are corrected. If the user does not input units on a particular value, the default units will be automatically added. The one caveat is that it is possible to enter bin width and bandwidth resolution values that are not supported by the components inside the spectrum analyzer. The program will attempt to correct some of these values, but some a priori knowledge concerning the proper usage of a given spectrum analyzer is required.

References to a given Analyzer Setting are tracked in this window. Analyzer Settings cannot be edited or deleted once they are linked to by sweeps performed during a measurement. If all

the sweeps that reference a particular analyzer setting have been deleted, an analyzer setting may be deleted as well.

### **4.1.2.3 Creating a Sweep Set**

Sweep sets order the sweeps that make up a measurement definition or instance (Figure 21). Individual sweeps link to a specific antenna profile and analyzer setting for a desired band. The user enters a name for the Sweep Set, such as “UHF and VHF bands”. Clicking save allows the user to enter other parameters of the sweep set. In the “Choose Antenna” drop-down box, the user can select one of the existing Antenna Settings profiles. In the “Choose Analyzer Settings” drop-down box, the user can select an Analyzer Settings profile. The sweep settings are saved by clicking on the “Save Sweep Settings” button. When multiple sweeps have been defined, the order of execution for the sweeps can be adjusted by selecting a sweep and clicking the “Move Up” or “Move Down” buttons. These Sweep Set Definitions can be saved and then run by clicking the “Run Test” button. Clicking this button establishes a link to the data collection device and begins the spectrum measurement.

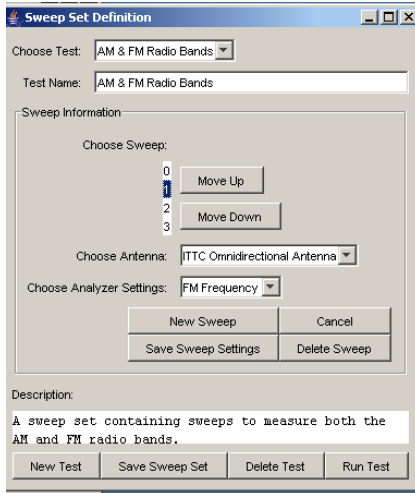

Figure 21 - Sweep Set Definition window

#### 4.1.2.4 Measurement options

The user can choose to schedule a measurement at a specific date and time or immediately start the measurement (Figure 22). To immediately start the measurement, the user un-checks the “Start test at:” checkbox. The measurement can be performed over a defined period of time or for a specific number of iterations of the Sweep Set. If a measurement is scheduled for a future time, a count down dialog box will display the amount of time remaining until the start of the measurement (Figure 23). The test can be canceled by clicking the “Cancel Test” button.

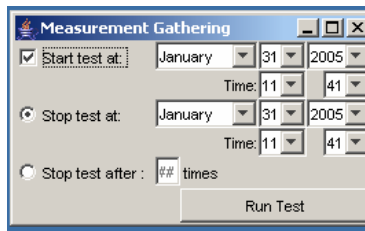
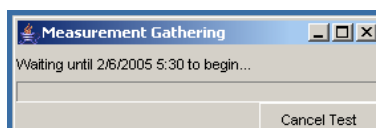

Figure 22 - Measurement Gathering Dialog



**Figure 23 - Count down dialog**

#### **4.1.2.5 Taking measurements**

A log window provides the user feedback while a measurement is being performed. A log message is displayed after each sweep and sweep set is completed. The user can cancel a test or close the window when a test has been completed.

#### **4.1.2.6 Spectrum Miner program settings**

This window allows the user to specify connections to data collection devices, GPS receivers and the local database (Figure 24). A data collection device can be accessed through a RS-232 serial port, General Purpose Interface Bus (GPIB) or SSH connection. The “Analyzer Com Port” drop-down box provides a list of spectrum analyzers that are currently connected to the host computer via GPIB or serial. It also provides a list of KUAR radios that are currently available on the local network. These radios can be controlled via an SSH connection and when selected are configured with a spectrum analyzer FPGA image. The Database Location field defines the location of the database, which can either be local or on another networked computer. The database user that is specified must have permission to access and modify the database specified in the Database Name field. Multiple databases can be created to help manage large datasets.

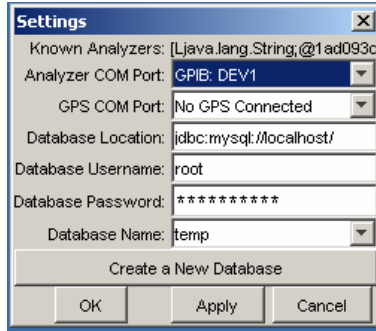

Figure 24 – Spectrum Miner Settings Window

### 4.1.2.7 Data Import and Export

The “Import” option on the toolbar allows the user to import measurements from either the Spectrum Repository or a third-party source. These measurements must either be in Comma Separated Value (CSV) or Spectrum Miner file formats.

The “Manage Data” window allows the user to export or delete measurements that are stored locally (Figure 25). The available Sweep Set Instances are displayed, along with the organization ID, date, time and location of the measurement.

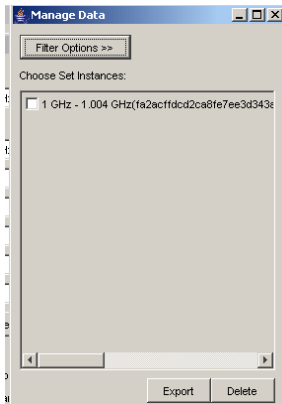
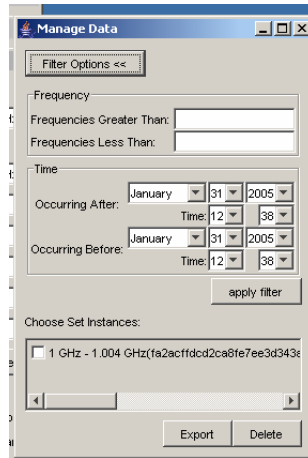

Figure 25 – Manage Data window

A filtering view is provided to help the user browse large numbers of Sweep Set Instances (Figure 26). This expanded window allows the user to filter measurements by the frequency span, date and time of the measurement. One or more measurements can be selected for deletion or for export to a variety of file formats (Figure 27). Measurements can also be exported directly into the workspace of a running instance of Matlab.



**Figure 26 - Manage Data Window with filtering options**

	A	B	C	D	E
1	Start Time	Stop Time	Frequency	Amplitude	
2	1/14/2004 13:41	1/14/2004 13:42	1000000000	-110.41	
3	1/14/2004 13:41	1/14/2004 13:42	1000010000	-108.87	
4	1/14/2004 13:41	1/14/2004 13:42	1000020000	-106.07	
5	1/14/2004 13:41	1/14/2004 13:42	1000030000	-109.21	
6	1/14/2004 13:41	1/14/2004 13:42	1000040000	-107.29	
7	1/14/2004 13:41	1/14/2004 13:42	1000050000	-107.54	
8	1/14/2004 13:41	1/14/2004 13:42	1000060000	-103.88	
9	1/14/2004 13:41	1/14/2004 13:42	1000070000	-106.72	
10	1/14/2004 13:41	1/14/2004 13:42	1000080000	-106.86	
11	1/14/2004 13:41	1/14/2004 13:42	1000090000	-106.82	
12	1/14/2004 13:41	1/14/2004 13:42	1000100000	-104.38	
13	1/14/2004 13:41	1/14/2004 13:42	1000110000	-104.76	
14	1/14/2004 13:41	1/14/2004 13:42	1000120000	-102.73	

**Figure 27 - Example CSV format file in Microsoft Excel**

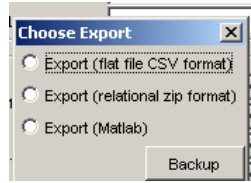

**Figure 28 - Export Dialog**

The Matlab export option creates a Matlab file that queries the MySQL database and creates data objects in the Matlab workspace (Figure 28). An example of a generated Matlab code that imports a measurement from the database is available in Appendix A.

### **4.1.3 Data Verification**

Before embarking on any spectrum measurement campaigns, the accuracy of the data collected by the Spectrum Miner program needed to be verified in the lab. Initial verification involved measuring known FM band signals. There is a large radio tower approximately 1 mile from the ITTC research center. This tower contains a variety of communications equipment, including transmitters for two local radio stations, KJHK 90.7 FM and KANU 91.5 FM. These two radio stations broadcast twenty four hours a day and have relatively constant transmitter output power (although their transmit power occasionally decreases in the early morning). FM radio stations were chosen for the verification process because a wealth of information about each station's operating parameters is available through the FCC FM Radio Database website [66]. The Spectrum Miner program was used to take measurements of both stations and the power values stored in the database were analytically compared to the values on the spectrum analyzer display. This check was performed for a variety of signals at various times throughout the day and it was found that the values stored in the Spectrum Miner database consistently matched the values on the analyzer screen. The



stored data was also compared against the FCC FM database and was found to match the operational parameters of the stations being measured.

## **4.2 *Spectrum Repository***

The Spectrum Repository is implemented as a Java web application running in the Tomcat servlet engine. It is designed to integrate with content management systems to help facilitate data sharing and manage user access controls (Figure 29). This web application allows various organizations that are performing spectrum measurements to upload their data in the Spectrum Miner file format. The data is then stored for archival purposes and made available to all participating organizations. The Spectrum Repository uses the same database schema as the Spectrum Miner program, allowing for data to be easily imported and exported. This shared schema allows the Spectrum Miner program (or a third-party program that implements the database schema) to either directly synchronize with the MySQL database running on the Spectrum Repository server or to use the preferred HTTP web application interface (Figure 30).

**Kansas Spectrum Group**

My Account Logout

Welcome rory

Main Menu ▾

- Home
- Agile Radios
- Spectrum Policy
- HOFDM
- National Radio Testbed
- Spectrum Miner
- NSF Workshops
  - Future of Spectrum
  - Wireless Networking
- Calendar
- Contact
- Documents
- Downloads
- FAQ
- News
- Photo Gallery
- Search
- Submit News
- Topics
- Web Links
- ITTC
- Spectrum Repository
- My Account
- Administration
- Spectrum Miner Bugs
- Logout

Calendar ▾

<< October 2004 >>

S	M	T	W	T	F	S
26	27	28	29	30	01	02
03	04	05	06	07	08	
10	11	12	13	14	15	16
17	18	19	20	21	22	23
24	25	26	27	28	29	30
31	01	02	03	04	05	06

Upcoming Events

No Events

Welcome to the Kansas Agile Radio Group

The Kansas Agile Radio Group is a research group at the University of Kansas that is actively engaged in research and development of agile radios. The group is a part of the [Networking and Wireless Systems Laboratory \(NWSL\)](#) at the [Information Telecommunications and Technology Center \(ITTC\)](#) at KU. Our goals are to further research in the areas of agile radios and spectrum policy through several projects:



1. Development of an Agile Radio Platform Kit that can be used by other universities and institutions for rapid radio development
2. Development of a National Radio Networking Research Testbed (NRNRT) to facilitate the testing and rapid development of next generation wireless technologies
3. Research and development of new modulation schemes and theoretical modeling techniques to advance the development of wireless technologies
4. Develop software to study regional spectrum usage and gather data to support policy analysis with regard to future spectrum policy

For further information contact [Dr. Gary Minden](#).

**Last week for IWANN2004 papers to be submitted** 5 Reads

This is the last week to submit papers for the IWANN 2004 conference. Please contact Dr. Minden if you have any questions concerning paper submissions.

 Agile Radios



comments?  

Posted by: rory >>> on Tuesday, May 25, 2004 - 07:37 PM

**Spectrum Miner 0.0 beta released** 12 Reads

Spectrum Miner 0.0 beta was released today. Contact Ted or Rory for the source and build instructions.

 Spectrum Miner

comments?  

Posted by: rory >>> on Thursday, April 15, 2004 - 11:23 PM

Figure 29 – Spectrum Repository integration with PHPNuke content management system

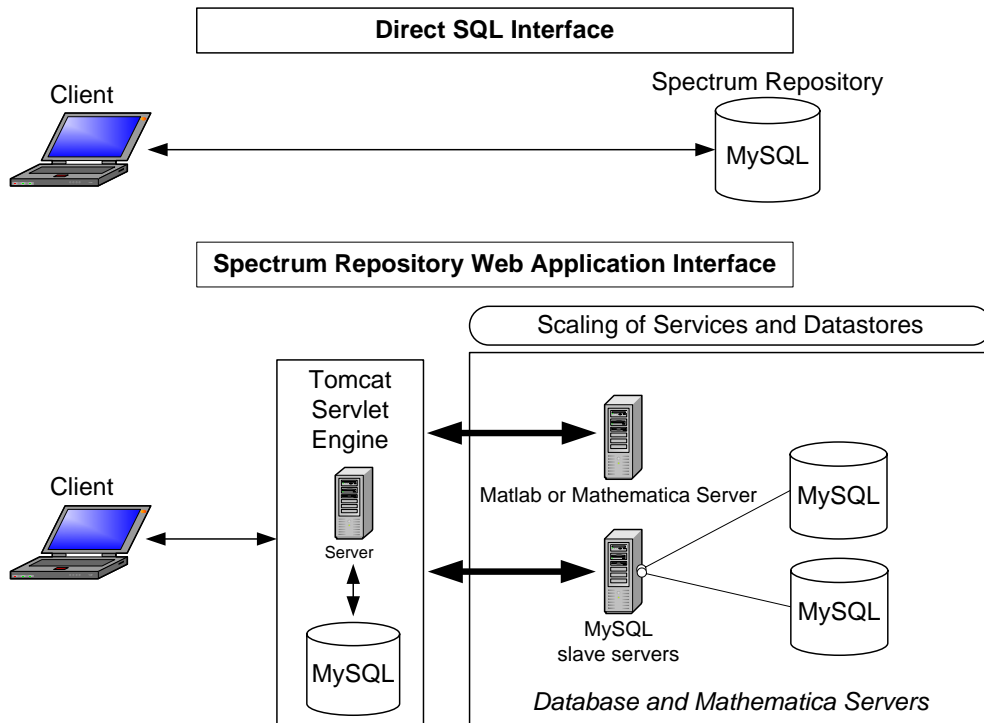

**Figure 30 – Remote client interface methods with the Spectrum Repository**

When the user logs into the Spectrum Repository, they are presented with a paginated list of the available spectrum measurements (Figure 31). The list can be filtered by searching for measurements that contain sweeps in a certain frequency band. For example, one measurement might sweep only the FM radio band, while another spans 80 MHz – 200 MHz. If the user searches for sweeps containing data in the range of 80 – 90 MHz, both of these measurement instances would be displayed.

**Kansas Spectrum Group**

My Account Logout Search

Welcome rory

Main Menu

- Home
- Agile Radios
- Spectrum Policy
- HFDN
- National Radio Testbed
- Spectrum Miner
- NSF Workshops
  - Future of Spectrum
  - Wireless Networking
- Calendar
- Contact
- Documents
- Downloads
- FAQ
- News
- Photo Gallery
- Search
- Submit News
- Topics
- Web Links
- ITTC
- Spectrum Repository
- My Account
- Administration
- Spectrum Miner Bugs
- Logout

Calendar

<< October 2004 >>

S	M	T	W	T	F	S
> 26	27	28	29	30	01	02
> 03	04	05	06	07	08	09
> 10	11	12	13	14	15	16
> 17	18	19	20	21	22	23
> 24	25	26	27	28	29	30
> 31	01	02	03	04	05	06

Upcoming Events  
No Events

### Spectrum Miner Repository > Search

Home Upload Search Manual Query Logout

#### Step 1 - Choose Sweep Set Definition

Sweep sets are definitions of the way a set of measurements was taken, the full definition of each sweep is available by clicking on its' name. Choose a sweep set which matches your preferences, then click on "Search for Sweeps". This will allow you to download actual data sets. The Next Page and Previous Page links beneath the list of Sweep Sets allows you to page through the results of your search.

**Refine your Search:**  
Limit to sweep sets including frequencies (you **must** type frequency unit after number i.e. 150 Mhz)  
Greater than:   
Less than:

Page: 1 of 72  
10 Results on this Page  
717 Total Matches

Name	Description
<input type="radio"/> <a href="#">1 GHz - 1.004 GHz</a>	This sweep was auto-generated during an update from version 0.8 to version 0.81.
<input type="radio"/> <a href="#">1 GHz - 1.004 GHz</a>	This sweep was auto-generated during an update from version 0.8 to version 0.81.
<input type="radio"/> <a href="#">1.004 GHz - 1.008 GHz</a>	This sweep was auto-generated during an update from version 0.8 to version 0.81.
<input type="radio"/> <a href="#">1.004 GHz - 1.008 GHz</a>	This sweep was auto-generated during an update from version 0.8 to version 0.81.
<input type="radio"/> <a href="#">1.008 GHz - 1.012 GHz</a>	This sweep was auto-generated during an update from version 0.8 to version 0.81.
<input type="radio"/> <a href="#">1.008 GHz - 1.012 GHz</a>	This sweep was auto-generated during an update from version 0.8 to version 0.81.
<input type="radio"/> <a href="#">1.012 GHz - 1.016 GHz</a>	This sweep was auto-generated during an update from version 0.8 to version 0.81.
<input type="radio"/> <a href="#">1.012 GHz - 1.016 GHz</a>	This sweep was auto-generated during an update from version 0.8 to version 0.81.
<input type="radio"/> <a href="#">1.016 GHz -</a>	This sweep was auto-generated during an update from

**Figure 31 – Spectrum Repository search and filtering interface**

After the user has filtered the search results by frequency range, they can further filter the results based on organization ID and date or time of the measurement (Figure 32). This makes it easy for researchers to find measurements specific to a given band or that took place during a date or time period of interest.

**Kansas Spectrum Group**

My Account Logout Search

Welcome rory

**Spectrum Miner Repository > Search**

Home Upload Search Manual Query Logout

**Step 2 - Choose Sweeps**  
Sweeps are the actual instances of Sweep Set Definitions that have been run on the analyzers. Sweeps vary by time and organizations. After checking what sweeps you want to download, select the format and click Download. The current supported formats are Spectrum Miner and CSV. The Spectrum Miner format is used to backup/export/import data for the Spectrum Miner application and the Spectrum Repository. The CSV format is a far more readable format that is meant to be opened in Microsoft Excel, Matlab, Mathematica or the graphing/numeric program of your choice.

**Refine your Search:**  
Limit to set instances  
From: All Organizations  
Occurring After: Date: October 8 2004 Time: 18 38  
Occurring Before: Date: October 8 2004 Time: 18 38  
refine search

Page: 1  
0 Results

	Name	Collected By	Starting Time	Ending Time
<input type="checkbox"/>	1.016 GHz - 1.020 GHz (a4571f696794e64f7b617e09023882ea)	KU Wireless Group	2004-01-14 13:44:47.0	2004-01-14 13:44:54.0

Comma delimited data file (single flat file)  
 Spectrum Miner zip file (relational format)

download file

**Calendar**  
 << October 2004 >>  
 S M T W T F S  
 > 26 27 28 29 30 01 02  
 > 03 04 05 06 07 08 09  
 > 10 11 12 13 14 15 16  
 > 17 18 19 20 21 22 23  
 > 24 25 26 27 28 29 30  
 > 31 01 02 03 04 05 06

**Upcoming Events**  
No Events

Figure 32 – Spectrum Repository search filtering by organization and date / time

After the filtering process, a list of measurement instances that meet the user’s specifications is displayed. One or more measurements can be selected using the checkbox next to the measurement name. The user can also select the export file format. The data is then compressed and presented to the user for download. This filtering system mirrors the “Manage Data” interface in the Spectrum Miner program.

In the future, the Spectrum Repository interface will add the ability to create Antenna and Analyzer Setting definitions directly on the website. This will allow researchers to indicate what types of measurements they are interested in, as well as the corresponding bands of interest. These settings could then be shared with researchers actively performing spectrum measurements, such that organizations that do not have the resources to perform spectrum measurement campaigns could now coordinate with those actively taking measurements.

## Chapter 5 – Measurements

The Spectrum Miner program has been used in a variety of measurement campaigns. Initial measurements for data verification and usage analysis were performed on broadcast bands such as the TV and FM bands. These bands exhibit very static, non-time varying signal properties. A majority of TV and FM broadcasters exhibit near 100% duty cycles during their operational hours. As part of the NRNRT program, the Spectrum Miner program was used for several long-term, wideband spectrum surveys ranging from 9 kHz to 1 GHz. Many of the signals in these bands are periodic or transient in nature. This was especially seen in measurements that monitored land mobile and aeronautical bands for twenty-four hour periods. Several short-term surveys of the 2.4 GHz ISM band also focused on measuring activity in bands with transient signals. This band in particular underscored the tradeoff between sweep time and resolution bandwidth and how these parameters play a major factor in resolving and capturing transient signals.

This section will highlight three case studies. Two of the studies provide detailed descriptions of measurement campaigns performed with the Spectrum Miner software. The third case study focuses on the use of the KUAR as a spectrum data collection device. The first case study features a measurement campaign focused on measuring a subset of the FM band for a twenty four hour period. This spectrum data, along with ground truth operation data from the FCC, was used to develop a signal classification algorithm that iteratively calculates a noise floor threshold for a band. A performance metric was also developed that analyzes the effectiveness of the aforementioned algorithm. The second case study highlights a measurement campaign designed to collect data regarding the operation of analog and digital

television channels in a medium-sized television market. The data set produced by this measurement was used by other KU research projects and culminated in a paper for the 2<sup>nd</sup> International Symposium on New Frontiers in Dynamic Spectrum Access Networks (DySpan 2007) conference.

## **5.1 Calibration and Verification**

Before beginning large scale measurement campaigns, measurement equipment must be calibrated and the data capture software discussed in the previous section must be verified. Spectrum measurement campaigns were performed with the HP and IFR spectrum analyzers. For the first campaign, a Times Microwave standard LMR-600 flexible low loss coaxial cable of 84 feet connected the antenna on the roof of the ITTC to the spectrum analyzer in the lab. In the second campaign, field measurements were taken using a mobile disc-cone antenna mounted on a mast and connected to the analyzer using a short coaxial cable. The use of a KUAR as a simple spectrum analyzer was verified in a laboratory setting.

The Times Microwave LMR cable was connected to a signal generator and the cable loss was measured using a spectrum analyzer. The loss of the cable was experimentally found to be -3.03 dBm over 2.001 GHz (Table 13). This matches the attenuation plot found on the LMR-600 datasheet [67] and verifies the frequency-selective loss across the cable (Figure 33). The HP and IFR spectrum analyzers were also calibrated by a technician prior to their use in the laboratory.



**Table 13 – Power loss for Times Microwave LMR-600 coaxial cable**

<b>Frequency (MHz)</b>	<b>Amplitude (dBm)</b>
497	-1.44
1001	-2.2
2001	-3.03
2498	-3.82

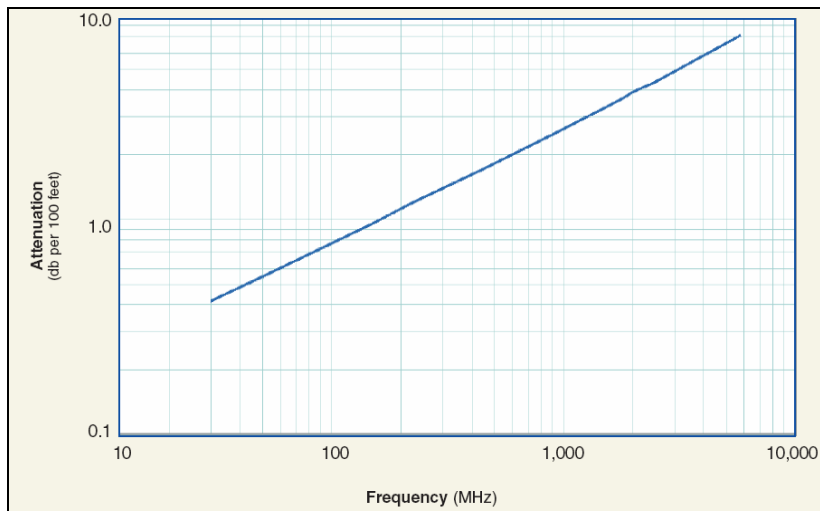

**Figure 33 – Official Times Microwave LMR-600 plot of power loss [67]**

## **5.2 Case Studies**

### **5.2.1 Case Study 1 – FM band measurement and development of signal classification algorithm**

A section of the FM band, 90 – 93 MHz was selected for an initial spectrum measurement.

This sub-band contains the radio stations KJHK 90.7 FM and KANU 91.5 FM as discussed in

Section 4.1.3. These stations were selected because of the proximity of their transmitters to the ITTC research center, their near twenty four hour operation and the wealth of information available from the FCC regarding their operational transmitter height, power, and location. The 90 – 93 MHz sub-band was measured over a twenty four hour period.

Figure 34 shows peaks throughout the twenty four hour period occurring consistently at 90.7 and 91.5 MHz. This plot provides a spectral and temporal view of the usage in the lower FM band. It also confirms the accuracy of the measurement data taken by Spectrum Miner, as the signals match the FCC license information for both stations. Verification of the Spectrum Miner program’s ability to resolve quickly changing signals can be seen in Figure 35. This plot is tightly focused on 90.7 MHz and the movement of the FM carrier between 90.65 and 90.75 can be clearly seen.

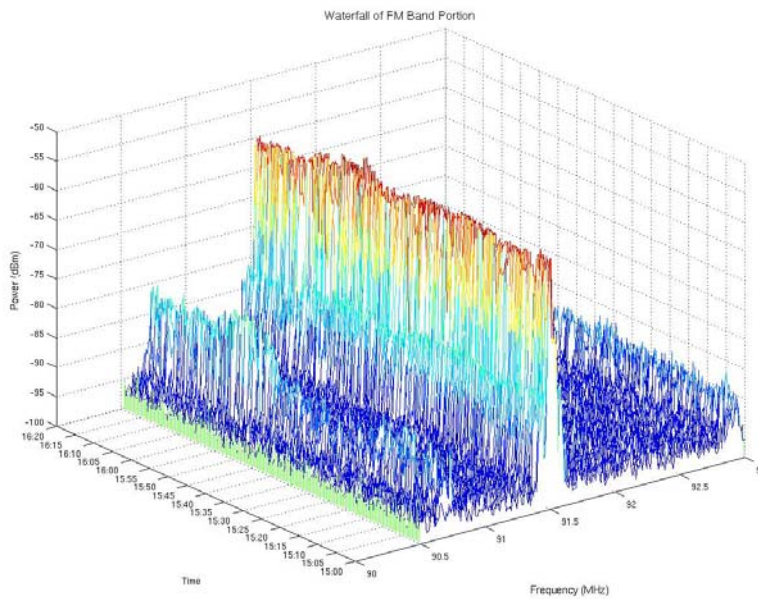

**Figure 34 – Waterfall plot of 90-93 MHz (FM band) over 24 hours in Lawrence, KS**

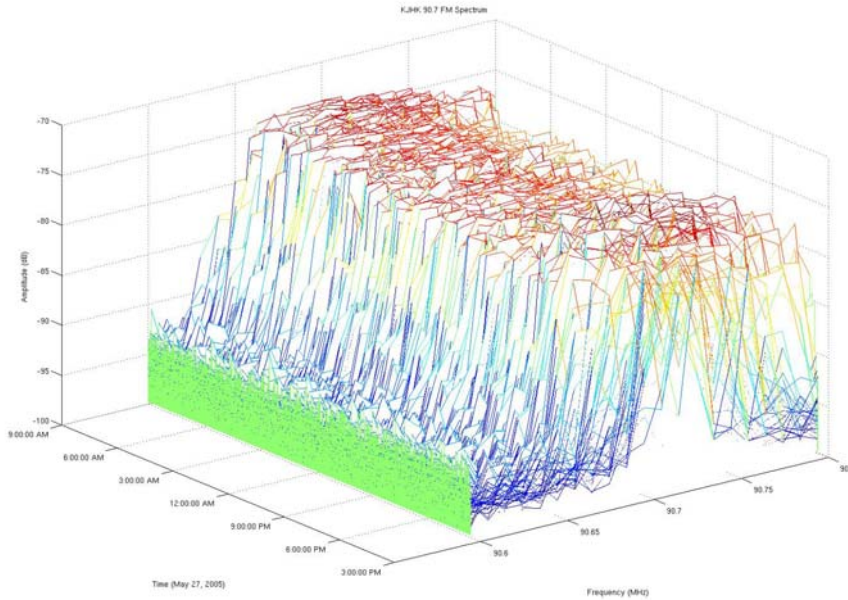

**Figure 35 – Waterfall plot of power (dBm) values over 40 minutes of FM station KJHK 90.7 in Lawrence, KS**

### **5.2.1.1 Development of signal classification algorithm**

After measuring the 90-93 MHz sub-band, a twenty four hour measurement was performed for the entire FM band. This data set can be represented as a matrix  $M[f_i, t_j]$ , where  $f_i$  is a frequency and  $t_j$  is a time instance. The value of each entry is the measured R.F. power in dBm. The frequency ranges from  $F_{Start}$  to  $F_{Stop}$ , which is defined in the Analyzer Settings in the Sweep Set Definition for this measurement. The measurement instrument quantizes the frequency range into discrete measurements that occur at multiples of  $F_{Step}$ . The frequency indices for measurements in this span are thus:

$$f_i = F_{\text{Start}} + i * F_{\text{Step}} \text{ for } i = 0..N_f$$

$$\text{where } N_f = (F_{\text{Stop}} - F_{\text{Start}}) / F_{\text{Step}}$$

Similarly, the time range from  $T_{\text{Start}}$  to  $T_{\text{Stop}}$  is quantized into multiples of  $T_{\text{Step}}$ .  $T_{\text{Step}}$  is usually determined by the time it takes the instrument to scan from  $F_{\text{Start}}$  to  $F_{\text{Stop}}$ , but may also be set by the user. Thus:

$$t_j = T_{\text{Start}} + j * T_{\text{Step}} \text{ for } j = 0..N_t$$

$$\text{where } N_t = (T_{\text{Stop}} - T_{\text{Start}}) / T_{\text{Step}}$$

A sub-matrix of  $M$ ,  $M_{F,T}$ , can be defined where  $F$  is a sub-range of  $[F_{\text{Start}}..F_{\text{Stop}}]$  and  $T$  is a sub-range of  $[T_{\text{Start}}..T_{\text{Stop}}]$ . A cumulative distribution function (CDF) can now be defined:  $\text{CDF}(S, M_{F,T}) = P(S \leq M[f_i, t_j])$  for  $f_i$  in  $F$  and  $t_j$  in  $T$  where  $S$  is a random variable representing measured power.

There are a variety of techniques that can be used to identify  $M[f_i, t_j]$  as either signal power or noise power. This threshold value is referred to as  $\theta$ . These techniques include the following examples:

1. Select an arbitrary decision threshold,  $\theta$ . If  $M[f_i, t_j] \geq \theta$ , it is classified as signal, otherwise it is noise. This approach typically requires a priori knowledge of the channel.
2. Select  $\theta$  from the CDF of  $M_{F,T}$ , that is:

$$\theta_s = \text{CDF}(S = \theta_s, M_{F,T})$$

Typical values of  $s$  might be between 0.5 and less than 1.0. If  $M[f_i, t_j] \geq \theta_s$  it is classified as a signal, otherwise it is noise.

3. Using a sub-matrix of  $M$  around  $M[f_i, t_j]$ , calculate the CDF for that sub-range and select  $\theta_s$  based on the CDF of the sub-range. This would allow for threshold calculations if the band changes in a predictable fashion (i.e. transmitter powers down at night).
4. Compute a marginal  $CDF_f$  for each frequency in the range and classify a frequency based on a statistic of  $CDF_f$ . For example, one might calculate the maximum measurement for  $f_i$  and if the maximum is above a threshold, classify  $f_i$  as a signal frequency.

To begin characterizing the FM band, a CDF is performed on the twenty four hour dataset (Figure 36). By visually inspecting the graph, it can be seen that a threshold of roughly -94 dBm will classify 90% of the measurements as noise. This methodology is only useful because the band being measured has very high dynamic range and the presence of very strong signals relative to the surrounding bands. The short coming of this and other qualitative approaches is that they require trained personnel and are not robust enough to support the type of automated signal detection algorithms that would be particularly useful in cognitive radio applications.

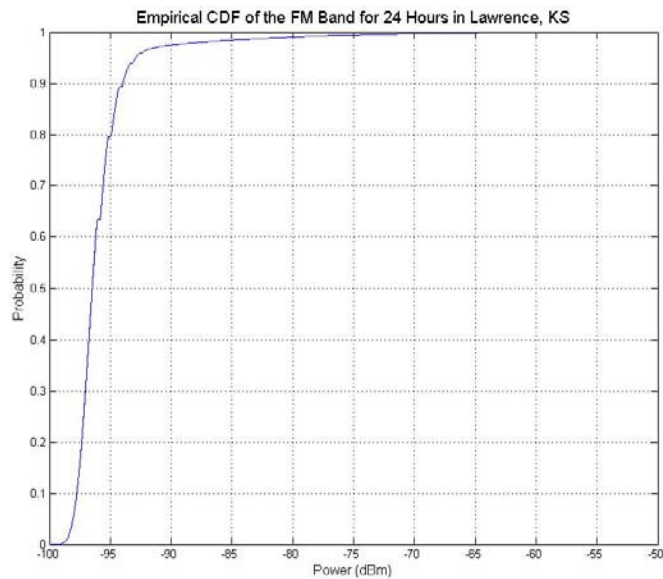

**Figure 36 – CDF plot of the measurements collected over 24 hours from the 90-93 MHz band in Lawrence, KS**

To address the short comings of manual threshold selection, an iterative algorithm that uses Recursive One-Sided Hypothesis Tests (ROSHT) with varying levels of statistical significance (p-values) was developed [68] [69]. This algorithm assumes that the noise in the channel is a Gaussian normal distribution, that there is more noise than signal in the band and that there are a sufficient number of points that the sample mean and standard deviation can be considered as the true mean and true standard deviation. The algorithm takes as an argument a value  $\epsilon$  that represents a termination condition for the algorithm. The value  $\epsilon$  represents the delta in variance between iterations of the algorithm. The algorithm thresholds a range of signal power by calculating a probability distribution, classifying a given percentage of measurements (based on the p-value) on the far right curve of the distribution as signal and classifying all other measurements as noise. To iteratively determine the

decision threshold, the algorithm discards the signal portion and re-calculates the probability distribution. The effect is that strong signals are discarded and the algorithm iteratively works towards finding the noise floor of the band. As the estimated signal portion of the band is removed, the Gaussian curve becomes tighter and the standard deviation decreases (Figure 37). The curve thus represents the estimate of the noise power in the given band and the statistics of the distribution represent the approximate decision threshold and its variance. The algorithm stops iterating when the change in the variance of the noise between two iterations is less than or equal to  $\epsilon$ . Experimentally, this value has been found to be 0.5 for most cases. The algorithm can also terminate if the value of  $\epsilon$  fails to change for a sufficient number of iterations.

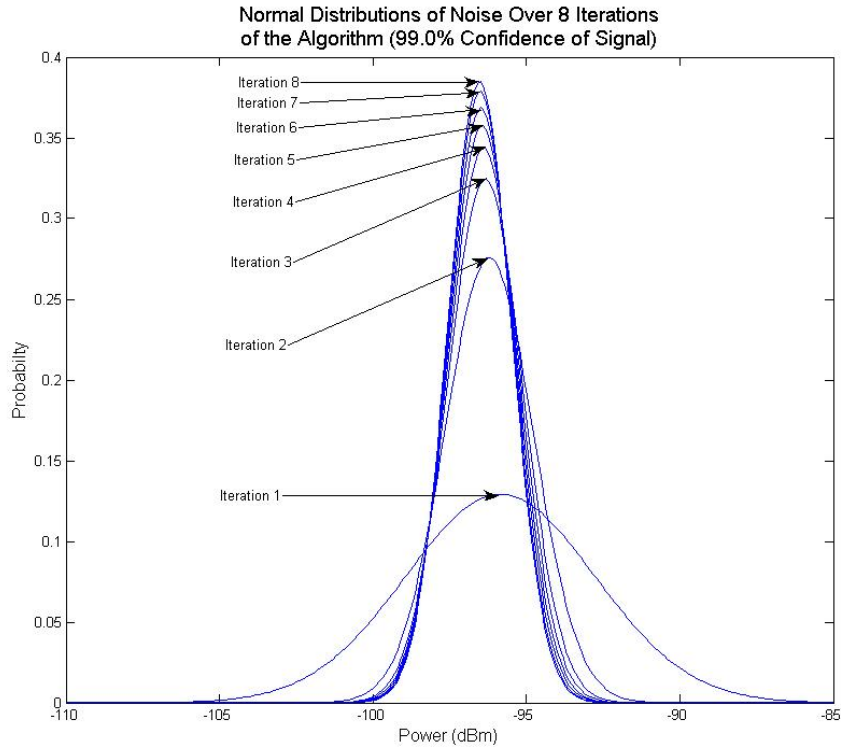

**Figure 37 – Normal distribution over 8 iterations of the ROSHT algorithm for a 99% confidence interval**

The algorithm is represented in pseudo-code as follows:

Given a certain p-value and  $\epsilon$

Let

M be the set of measurements  $M[f_i, t_i]$

S be the set of signals within M

$S_k$  be a subset of S for a given iteration of the algorithm

Q be the set of noise within M

$Q_k$  be a superset of Q for a given iteration of the algorithm that may still contains signals

$\mu_i$  = mean of  $Q_i$  and  $\sigma_i$  = standard deviation of  $Q_i$

$S = \emptyset, S_0 = \emptyset, Q_0 = M, i = 0$

do



$$\theta_{i+1} = pvalue * \sigma_i + \mu_i$$

$$S_{i+1} = \{q_k \mid q_k \in Q_i \text{ and } q_k \geq \theta_i\}$$

$$Q_{i+1} = Q_i - S_{i+1}$$

$$S = S \cup S_{i+1}$$

$$i = i + 1$$

until  $(\sigma_{i-1} - \sigma_i) \leq \epsilon$

Figure 38 shows the algorithm for multiple iterations, demonstrating how it progressively extracts signals from the noise in a band. Figure 39 shows how changing the confidence interval affects the proportion of the Gaussian distribution's tail that is considered signal and thus affects the ratio of estimated signal to noise in the band. The duty cycle plot in Figure 39 also helps to validate the data, as the majority of FM broadcast stations should be on twenty four hours a day. Figure 40 shows a duty cycle plot of the FM radio stations identified by the ROSHT algorithm.

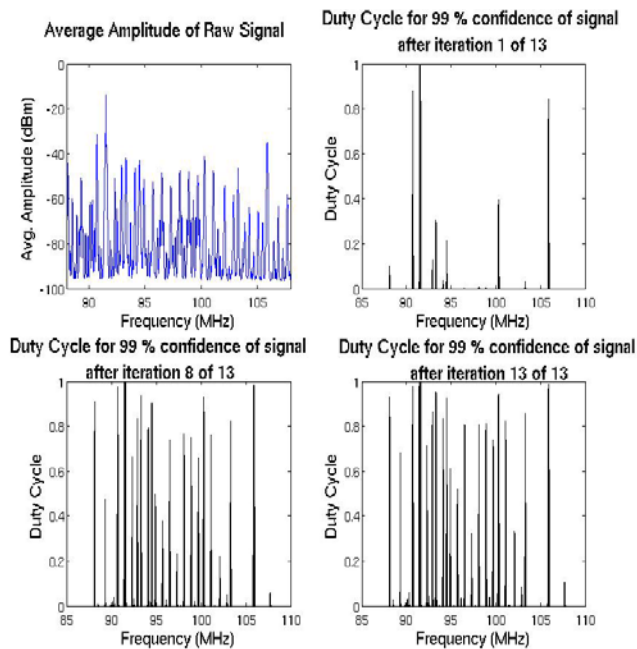

**Figure 38 - Iterations of the Hypothesis Testing algorithm for 99% confidence of signal**

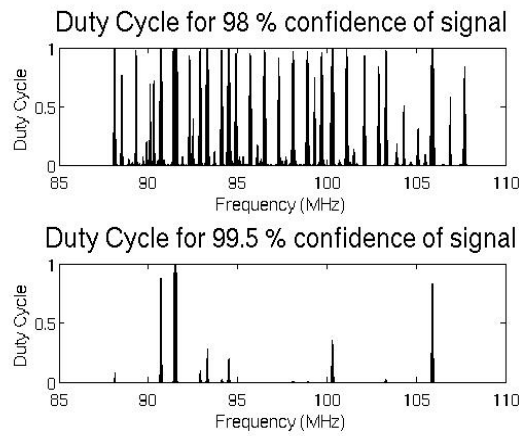

**Figure 39 - Comparison of duty cycle for varying confidence interval values (24 hr. measurement of the FM band)**

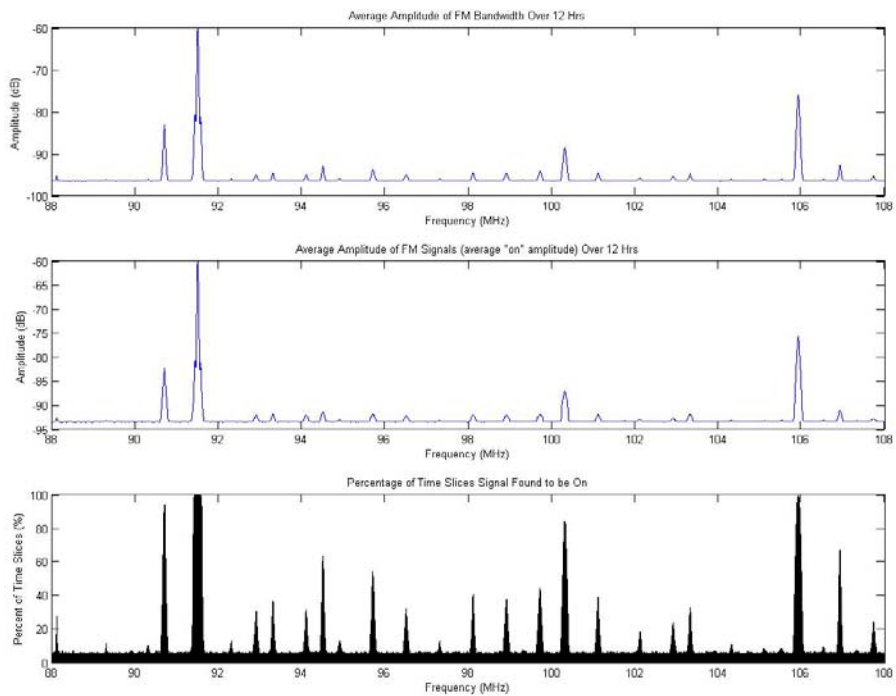

**Figure 40 – Duty cycle plot of detected FM stations using the ROSHT algorithm**

### **5.2.1.2 Performance Metric for the Classification Algorithm**

In order to analyze the effectiveness of the ROSHT algorithm, a performance metric must be established using known values. The FCC website provides the capability to search within a specified geographic radius for all licensed FM and TV. Operating parameters of these broadcasters, including GPS coordinates, power and height of the transmitter are provided. This data can be used in conjunction with FCC FM and TV propagation curves to calculate the approximate effective radiated power (ERP) that the spectrum analyzer should be measuring during the measurement test. The effectiveness of the algorithm can be determined by comparing the probability of false alarm to the probability of misdetection for a variety of confidence intervals. A false alarm is defined as incorrectly classifying noise as signal. A misdetection is defined as the incorrect classification of signal as noise.

In cognitive radio or dynamic spectrum access implementations, the highest importance is typically placed on minimizing the probability of misdetection. This prevents the radio from inadvertently identifying weak transmission as noise, identifying the band as open and then opportunistically using that band. For verification of known signals in known bands, a higher importance is placed on the probability of false alarm so that broadcasters with comparatively low power signals or broadcasters that are on the edge of the geographic market are not classified as noise. Table 14 shows that for verification of known signals, the ROSHT algorithm produces the best results (low false alarm rate) for a 99.5% confidence interval. This high confidence interval was able to detect virtually all of the stations that were considered by the FCC to be legal broadcasters within the geographic region surrounding Lawrence, KS. At this confidence interval, less than 1/1000<sup>th</sup> of a percent of signals were misidentified as noise. For a dynamic spectrum access scenario, the probability of

mis-detection is minimized by using a 95% confidence interval. The confidence interval with the best balance between the two detection and mis-detection classes is the 97% confidence interval, which has the best ratio between the two scenarios. For further discussion of signal detection and analysis, see Dinesh Datla’s thesis “Spectrum Surveying for Dynamic Spectrum Access Networks” [50].

**Table 14 - Classification probabilities for FM band spectrum measurements**

<b>Confidence Intervals</b>	<b>Probability of False Alarm</b>	<b>Probability of Mis-detection</b>
95%	47.89%	$3.6 \times 10^{-2}\%$
97%	41.73%	.17%
98%	1.27%	27.05%
99%	0.1%	50.92%
99.5%	$1.7 \times 10^{-3}\%$	88.18%

## **5.2.2 Case Study 2 – Analog and Digital Television Measurements at the WIBW television tower**

### **5.2.2.1 Background**

Real-world spectrum data can enable a variety of research projects. In the area of dynamic spectrum access, a current topic of interest is the viability of using television band whitespace for unlicensed device usage. There are two basic interference scenarios that might prevent unlicensed devices from effectively operating in TV whitespaces. The first scenario addresses the failure of an unlicensed device to detect a primary user, namely a DTV broadcast. Additionally, unlicensed devices operating in a band that is co-channel to an over the air

(OTA) television channel might cause interference to a DTV receiver if there is significant out-of-band power leakage. In the second scenario, the presence of strong TV transmissions that occur spatially near a secondary user can lead to the generation of spurious signals, intermodulation products, and saturation effects in the vacant bands [76]. These interference scenarios could occur at the transmission source, at the DTV receiver or at the secondary user receiver. Unoccupied portions of the spectrum may also contain spurious signals or be licensed for other purposes, such as public safety or Part 15 devices.

In dynamic spectrum access networks, secondary users must operate without causing harmful interference to primary users, with respect to both the transmission and reception of primary user signals. There is some debate within the regulatory community as to whether unlicensed devices can operate in unlicensed television bands without causing co-channel interference to primary users. Incumbent rights holders, represented by the National Association of Broadcasters and the Association for Maximum Service Television, claim that the operation of OTA digital television receivers and other Part 15 devices such as wireless microphones will be harmed by the operation of unlicensed devices in television whitespaces [70] [71]. There is a substantial body of research from the technical community however that suggests that television signals are easily detectable [72], that co-channel operation is possible with basic operational restraints [73] [74] and that such unlicensed device operation will enable broadband access to millions in rural communities [75].

The development of an Unlicensed Device Emulator and Testbed by at the University of Kansas (KUUDET) has helped to provide research that verifies the co-existence of unlicensed devices and primary OTA digital television receivers [73]. This testbed has helped

to provide technical answers to the first interference scenario outlined in the previous paragraphs. To address the second interference scenario, University of Kansas researchers needed to perform a spectrum measurement campaign to collect data from both an analog and digital television station. This data was then used in an unlicensed device simulation to study how proximity to a high power television transmitter, inter-modulation effects and other variables might affect unlicensed device usage.

### **5.2.2.2 Field Measurements**

In order to study the interference experienced by a secondary device in close physical proximity to TV transmitters, three sets of spectrum power measurements were collected at various distances from a TV tower transmitting both analog and digital signals. The broadcast tower for the WIBW television station located west of Topeka, Kansas (USA) was selected because there were few transmitters nearby both geographically and spectrally. There was also a separation of over 400 MHz between its analog and digital stations. This allowed for the measurements to include unused surrounding channels for the purpose of identifying inter-modulation or saturation effects.

Figure 41 shows the measurement equipment used in the field. An omni-directional disc cone antenna is connected to the input port of the IFR-2398 spectrum analyzer. The Spectrum Miner software is installed on a laptop computer and it controls the IFR 2398 spectrum analyzer over an RS-232 serial connection. A DC to AC converter plugged into the vehicle's cigarette lighter port provided power for the measurement equipment.



**Figure 41 – Field measurement equipment**

The measurements were collected on September 1, 2006 between 4:30–6:15 PM (US Central Standard Time) for TV channels 13 and 44. These channels are part of the Topeka, KS metropolitan-area television market. Channel 13 is an analog OTA television channel operating at 210–216 MHz with an ERP of 316 kW. Channel 44 is a digital OTA television channel operating at 650 - 656 MHz with an ERP of 193 kW. The measurements were collected at increasing line-of-sight distances of 200, 600, and 5000 feet from the WIBW TV tower. The GPS coordinates of the measurement locations west of Topeka, KS are listed in Table 15 while Figure 42 shows the geographic locations of the measurement sites.

**Table 15 – Measurement site GPS coordinates**

<b>Site</b>	<b>Coordinates</b>	<b>Elevation</b>
A	39°00.408N, 96°02.946W	1298 ft.
B	39°01.565N, 96°02.914W	1090 ft.
C	39°05.261N, 96°03.169W	1000 ft.

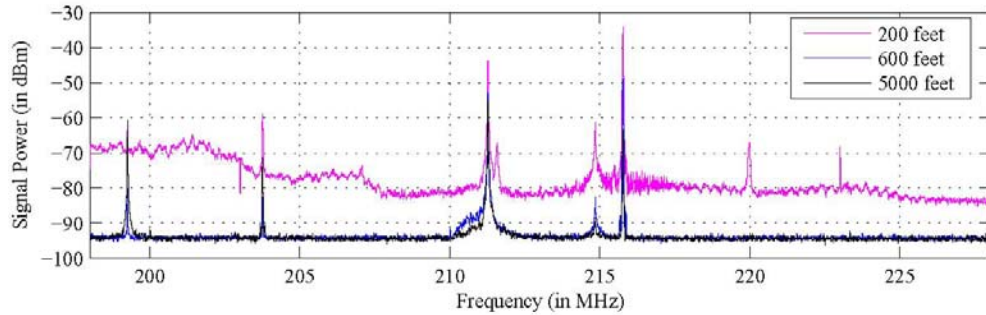

**Figure 42 – Map of the measurement locations**

In order to study the impact of inter-modulation and saturation effects on secondary transmissions, the sweeps of the TV channels included 12 MHz of bandwidth on either side of each channel. The total bandwidth for each sweep was thus 30 MHz and a bandwidth resolution of 10 kHz was selected. At each measurement site, 25 sweeps were recorded over the 30 MHz bandwidth centered on both the analog and digital TV channels. The plots of the



average power spectrum measured at increasing distances from both the analog TV and the DTV towers are shown in Figure 43 and Figure 44.



**Figure 43 – Averaged power measurements of analog TV spectrum for Channel 13 (210-216 MHz) measured at varying distances from the transmitter**

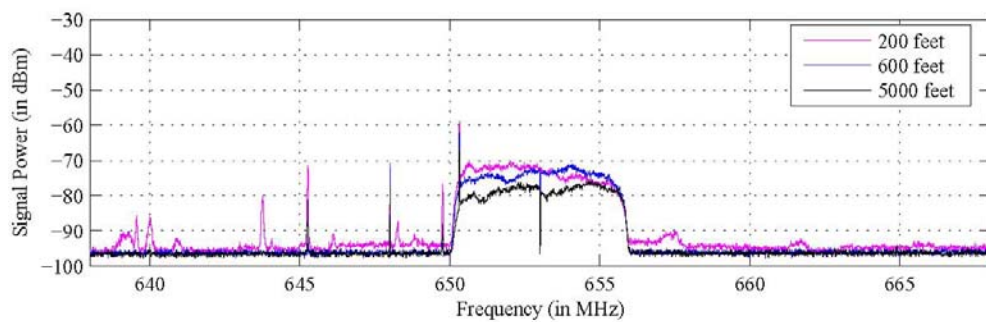

**Figure 44 – Averaged power measurements of digital TV spectrum for Channel 44 (650 – 656 MHz) measured at varying distances from the transmitter**

After the completion of the measurement campaign, the spectrum data was used in an unlicensed device simulation. This real world data made the simulation far more realistic than if the channel environment was merely simulated. The simulation was designed to analyze the impact of TV transmission on the operation of unlicensed devices. By measuring the TV band spectrum at various distances from the tower, the simulation was able to emulate the

behavior of a mobile unlicensed device that is operating at varying distances from the primary user. Unlicensed device activity was simulated by transmitting OFDM symbols in the adjacent 12 MHz surrounding each of the measured TV bands. Further information regarding the results of the simulation and the feasibility of dynamic spectrum access in TV spectrum can be seen in [77].

### **5.2.3 Case Study 3 - KUAR laboratory measurements**

As discussed in Section 4.1.1.3, reconfigurable hardware and software have been developed for the KUAR that allow it to act as a low cost, mobile spectrum analyzer. Spectrum analyzers are primarily designed for laboratory use and have prices that range well into tens of thousands of dollars. The ability to use low cost SDR platforms for mobile, distributed spectrum measurements creates a vast range of new research opportunities.

The KUAR RF Board receives modulated signals in the 5.25 – 5.85 GHz range and converts them to baseband. An Analog Devices demodulator separates the complex signal into I and Q signals, which are then sampled by the ADC. When the KUAR is configured as a simple spectrum analyzer, the FPGA is programmed to include signal sampler hardware that stores a configurable number of samples from the ADC in two FIFOs. A complex FFT is performed on the captured I and Q samples, providing a frequency domain representation of the received signal. The output of the FFT is transferred to the KUAR CPH and this data is then sent across an SSH connection to the computer that is running the Spectrum Miner program.

The Spectrum Miner program performs several data “massaging” steps before the spectrum data is stored in the local database. First, the FFT data is re-ordered. The Xilinx FFT IP core that is used in the FPGA returns the frequency data in an array where amplitude values are

provided from DC to 40 MHz, with amplitude values for -40 MHz to DC concatenated on the end. This is re-ordered so that amplitude array ranges from -40 MHz to 40 MHz (Figure 45).

### ***Xilinx FFT IP Core output array***

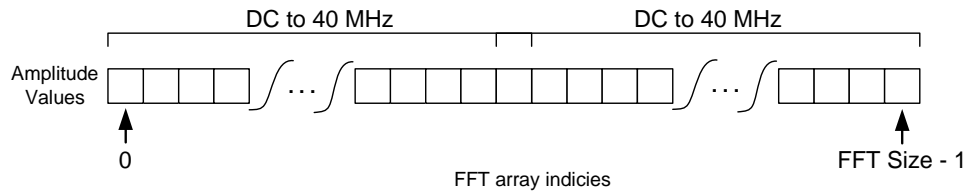

### ***Spectrum Miner FFT array re-ordering***

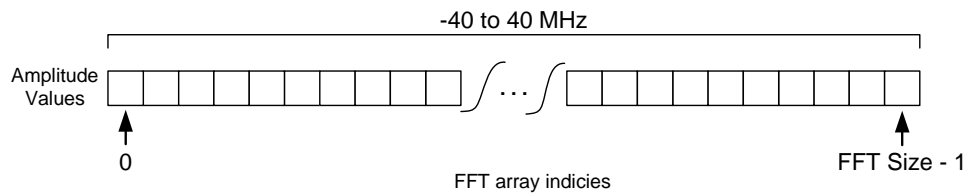

**Figure 45 – Spectrum Miner re-ordering of frequency domain samples from KUAR FFT**

The second step involved is the removal of a large DC offset that exists on the RF Board. DC offsets are averaged over several sweeps and then subtracted from the amplitude array. This allows the recorded amplitude and frequency information to correctly reflect the signal being measured.

The amplitude values that the ADC measures are relative power values, which are dependent on antenna loss, receiver gain, transmitter gain, and various component values in the RF Board signal chain. These values are also relative to the specific ADC used on the digital board. Different ADCs on the version 2 and 3 KUAR digital boards will result in different

relative measurements on each board. An attempt was thus made to calibrate these relative values to a unit of significance, such as decibels per milliwatt (dBm). Given that a decibel is a logarithmic unit of measurement, the relative power values need to be converted to a log scale. This is accomplished by squaring the magnitude of the FFT sample, taking the log and multiplying by ten (Equation 3).

**Equation 3 – Conversion of FFT relative power values to decibel**

$$dB = 10 * \log_{10}(|FFT|^2)$$

Several steps were performed to calibrate the power values measured on the KUAR. First, a Wiltron 68147B signal generator (SG) was connected to a HP 8565E spectrum analyzer via a United Microwave Products Microflex 150 cable. A tone was generated at 5.31 GHz and transmitted across the cable at varying gain levels (Table 16). This step served as a sanity check to ensure that the measured values on the spectrum analyzer were similar to the transmitter gain values from the signal generator. The approximately 2 dB difference between the signal generator output power and the values measured on the spectrum analyzer is due to the loss in the cable.

**Table 16 – Signal Generator and Spectrum Analyzer power measurement verification**

<b>Wiltron 68147B Signal Generator Output Power (dBm)</b>	<b>HP 8565E Spectrum Analyzer Received Signal (dBm)</b>
-20	-22.5
-15	-17.33
-10	-12.77
-5	-7.17
0	-2

After the accuracy of power measurements on the spectrum analyzer was verified, the spectrum analyzer was placed side by side with the KUAR (Figure 46). The signal generator was placed six feet away from both the spectrum analyzer and the KUAR. KUAR patch antennas were used on the signal generator, spectrum analyzer and the KUAR. The signal generator was used to transmit a tone at 5.31 GHz with varying output power. The Cerf2 KUAR radio was used for the test. The receiver gain on the KUAR was set to 58 dB and the attenuation level was set to 0 dB. Automatic gain control was turned off for the measurements. By transmitting a tone over the air to both the spectrum analyzer and the KUAR, relative power values measured on the KUAR (Figure 47) could be compared with calibrated, measured values on the spectrum analyzer (Table 17). To make a proper comparison, the KUAR relative power values are converted to dB using Equation 3 (Figure 48). Any difference between measured values on the KUAR and spectrum analyzer could then be corrected by applying an averaged correction factor. This correction factor modifies the KUAR relative power values (in dB) such that they are approximately the same as measured values on the spectrum analyzer (Figure 49). The plots for all of the KUAR measurements can be seen in Appendix B.



Figure 46 – HP spectrum analyzer and KUAR calibration setup

Table 17 – Comparison of tone power measurements on KUAR and HP Spectrum Analyzer

Signal generator output power of tone (dBm)	Spectrum Analyzer Measured Power of tone (dBm)	KUAR relative power value from ADC	KUAR power value converted to dB	Difference between Spectrum Analyzer and KUAR measurements (dBm)
-20	-61	0.003	-50.14	-10.86
-15	-57	0.005916	-44.56	-12.44
-10	-51.5	0.01075	-39.38	-12.12
-5	-46.3	0.01943	-34.23	-12.07
0	-41.3	0.03357	-29.48	-11.82

These differences between measurements from the SA and KUAR, when averaged, produce a correction factor of -11.862 dBm. This value can be added to values measured on the KUAR after converting to log scale. While this measured value is still relative, it approximates

identical measurements on the spectrum analyzer. This enables the KUAR to perform coarse-grained, distributed spectrum measurements and provide usable data. If exact measurements are required, the KUAR can be replaced with a spectrum analyzer.

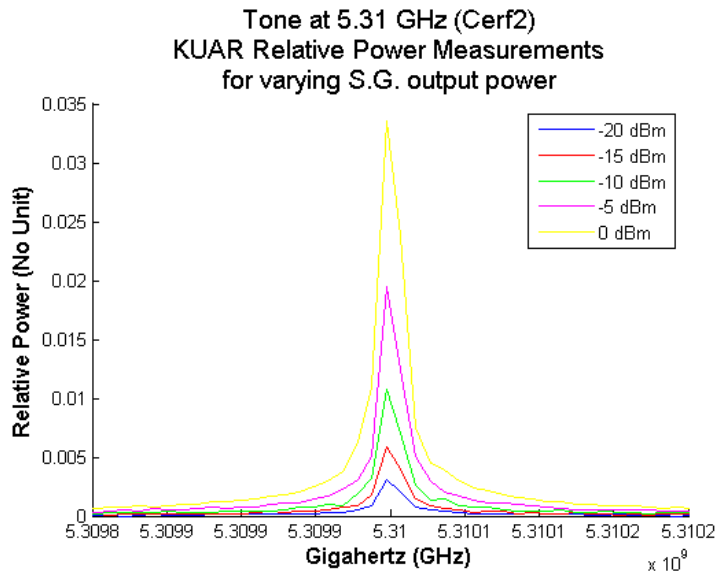

**Figure 47 - KUAR measured relative power values of a tone at 5.31 GHz for varying signal generator output power transmitted over the air in the laboratory**

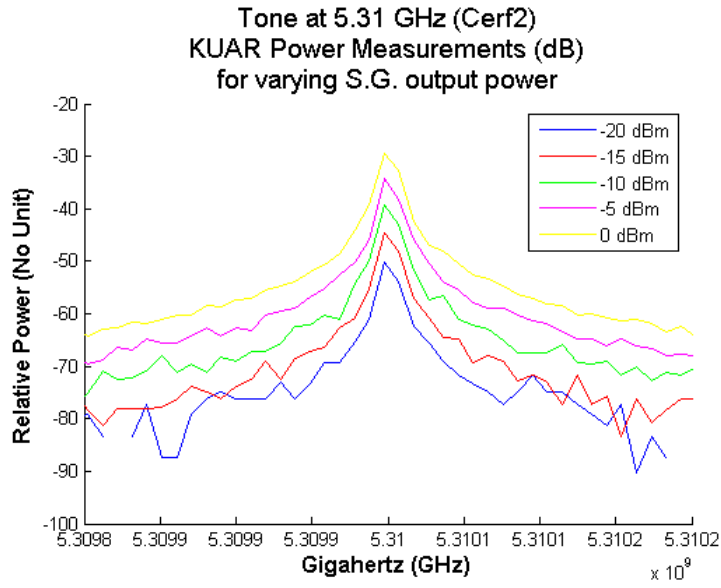

**Figure 48 - KUAR measured power values in dB of a tone at 5.31 GHz for varying signal generator output power transmitted over the air in the laboratory**

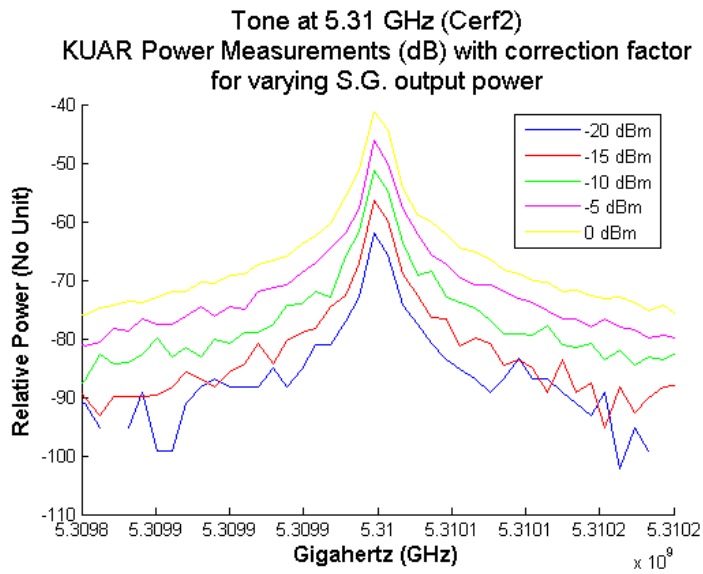

**Figure 49 - KUAR measured power values (dB) with a correction factor of a tone at 5.31 GHz for varying signal generator output power transmitted over the air in the laboratory**



In order to simply add a correction factor, there must be a linear relationship between the measured power values from the spectrum analyzer and the measured power values from the KUAR. Figure 50 shows that the received measured power of the KUAR and the spectrum analyzer exhibits a linear relationship across varying levels signal generator output power.

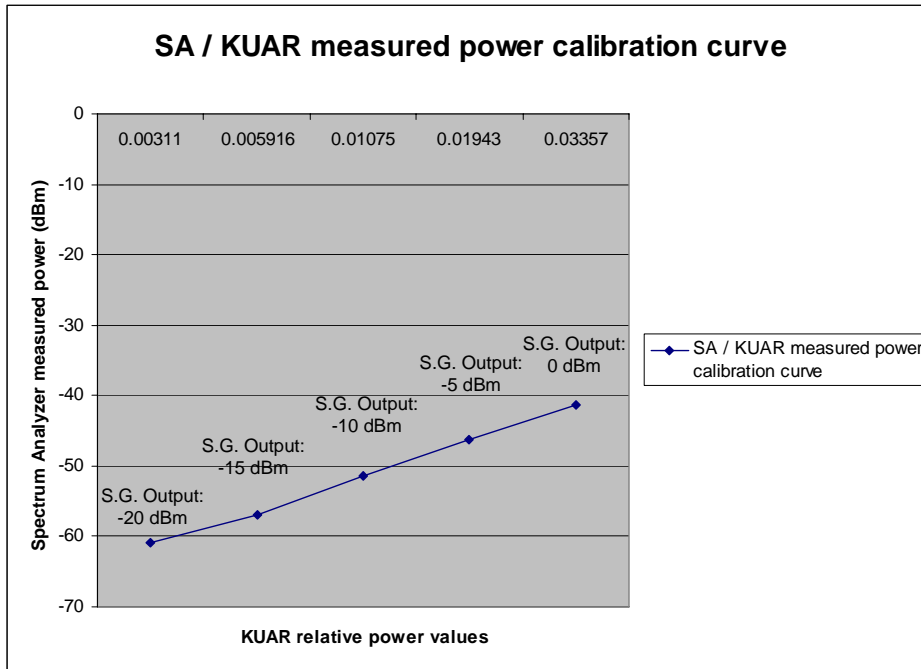

Figure 50 – Relationship between KUAR and SA measured power for varying SG output power

The KUAR was not designed as a piece of laboratory test equipment and thus cannot be truly labeled as a spectrum analyzer. The design and use of a super-heterodyne receiver as a spectrum analyzer could encompass an entire thesis. This subsection demonstrates however that the KUAR can be used as a low cost, field-deployable spectrum data collection device. This type of functionality can enable large-scale distributed spectrum measurement campaigns.

As noted previously, power levels measured on the KUAR are represented in arbitrary measurement units that are proportional to logarithmic power units, such as decibels. Measurements on the KUAR are not accurate when compared to measurements performed on calibrated lab equipment. KUAR measured power levels are highly dependent on a variety of parameters and settings in the antenna, RF Board and Digital Board. They can however be calibrated against reference measurements to provide approximate and acceptable power values. Despite its limitations, the KUAR can be an effective tool for spectrum data collection. Future work will focus on further developing KUAR hardware and software to enable Spectrum Miner to control multiple radios in the field simultaneously.

## **Chapter 6 – Conclusion**

This thesis provides an overview of the development of a framework and platform designed to enable large-scale, distributed spectrum measurement campaigns by multiple research organizations. This framework can help facilitate research and development in the areas of dynamic spectrum access, cognitive radios and spectrum management. The background literature section of the thesis also provides an overview of the current state of affairs in spectrum policy and regulation, as well as the development of spectrally agile and efficient technologies.

This thesis details the development of a shared database schema for large-scale, long term and high volume spectrum measurements. It addresses the development of the Spectrum Miner program, which automates the process of performing long-term spectrum measurements. The design and implementation of the Spectrum Repository, a central archive for shared spectrum measurements is discussed. The design of hardware and software that enables a software-defined radio to act as a spectrum data collection device is covered. Finally, various case studies are presented demonstrating how the KU Spectrum Utilization Framework enables spectrum measurement campaigns and various types of spectrum usage analysis.

### **6.1 *Future Work***

The research areas addressed in this thesis are ripe with possibility. There are a variety of additions that can be made to the implementations discussed in the thesis. One area includes separating the user interface, logic and data processing in the Spectrum Miner program so

that it can run as a command-line “server” program without a user interface. This would allow the Spectrum Miner program to run on SDR platforms without a display. Additionally, the program could be easily extended to control multiple data collection devices from a single program instance. That would allow one program instance to control an entire distributed measurement, assuming the number of data collection devices does not saturate the network link back to the computer where the program is running. In the event that there are a large number of spectrum data collection devices or the network connection to the data sink node is faulty, a store and forward architecture could be implemented to reliably transmit spectrum data back to the central Spectrum Repository server. Network Time Protocol (NTP) synchronization should also be added to coordinate the timestamps of multiple data collection devices. Finally, the use of the KUAR as a data collection device should be tested in the field and broader calibration tests should be performed.

## References

- [1] G. Staple and F. Werbach “The End of Spectrum Scarcity” IEEE Spectrum, April 2004. Website: <http://www.spectrum.ieee.org/apr04/3811>
- [2] W. Lehr, “Spectrum Management Reform” Spectrum policy lecture presentation, March 8, 2006. Website: [http://ocw.mit.edu/NR/rdonlyres/Engineering-Systems-Division/ESD-68JSpring-2006/0D4F480A-1770-4ECB-A2D8-4268CF8C76ED/0/mod3a\\_lec2.pdf](http://ocw.mit.edu/NR/rdonlyres/Engineering-Systems-Division/ESD-68JSpring-2006/0D4F480A-1770-4ECB-A2D8-4268CF8C76ED/0/mod3a_lec2.pdf)
- [3] M. A. McHenry, “NSF spectrum occupancy measurements - project summary.” Shared Spectrum Company, Aug. 2005.
- [4] R. Matheson, “The Electrospace Model as a Frequency Management Tool”, Addendum to the Proceedings of the 2003 ISART conference, pp. 126-132
- [5] G.J. Minden, J.B. Evans, J.A. Roberts, “Agile Radio Systems and A National Radio Networking Research Testbed” Presentation at the SensorNet Architecture Forum, August 13, 2003. Website: [http://www.ittc.ku.edu/workshops/sensornet/gary\\_minden.pdf](http://www.ittc.ku.edu/workshops/sensornet/gary_minden.pdf)
- [6] Media Access Project, “Ex Parte Comments of Prometheus Radio Project, Consumer Federation of America, Public Knowledge, Champaign-Urbana Community Wireless Project, Benton Foundation, Electronic Frontier Foundation, New America Foundation, The Dandini Group, Wireless Tech Radio, and NYCWireless”, Ex Parte Comments on ET Docket No. 03-237, June 18, 2004. Website: [http://www.newamerica.net/files/archive/Doc\\_File\\_1876\\_1.pdf](http://www.newamerica.net/files/archive/Doc_File_1876_1.pdf)
- [7] J.H. Snider, “The Economic Case for Re-Allocating the Unused Spectrum (White Space) Between TV Channels 2 and 51 to Unlicensed Service” New America Foundation Issue Brief #18, February 2006. Website: [http://www.newamerica.net/files/archive/Doc\\_File\\_2898\\_1.pdf](http://www.newamerica.net/files/archive/Doc_File_2898_1.pdf)
- [8] M. Powell, “Broadband Migration III: New Directions in Wireless Policy”, speech at the Silicon Flatirons Telecommunications Program at the University of Colorado Boulder, October 30, 2002. Website: <http://www.fcc.gov/Speeches/Powell/2002/spmkp212.html>
- [9] T. Hazlett, G. Rosston, “Why airwaves should be deregulated” CNET News Perspective article, February 11, 2004. Website: [http://news.com.com/2010-1039\\_3-5156846.html](http://news.com.com/2010-1039_3-5156846.html)
- [10] B.K. Marcus, “The Spectrum Should Be Private Property: The Economics, History and Future of Wireless Technology”, Article from Ludwig von Mises Institute, October 29, 2004. Website: <http://www.mises.org/story/1662>
- [11] National Telecommunications and Information Administration, “NTIA Federal Long-Range Spectrum Plan”, NTIA Website, <http://www.ntia.doc.gov/osmhome/LRSP/LRSP1.htm>
- [12] Congressional Budget Office, “Where do we go from here? The FCC auctions and the future of radio spectrum management,” April, 1997.
- [13] M. Spicer, “International Survey of Spectrum Assignment for Cellular and PCS”, FCC Wireless Telecommunications Bureau, September 1996.
- [14] M.D. Gallagher, "Managing Radio Frequency Spectrum: Military Readiness and National Security", Testimony before the Subcommittee on National Security, Veterans Affairs, and International Relations - Committee on Government Reform - U.S. House of Representatives, April 23, 2002, Website: [http://www.ntia.doc.gov/ntiahome/congress/2002/specman\\_04232002.htm](http://www.ntia.doc.gov/ntiahome/congress/2002/specman_04232002.htm)
- [15] Spectrum Policy Task Force, Report – ET Docket No. 02-135, November 2002, Website: [http://hraunfoss.fcc.gov/edocs\\_public/attachmatch/DOC-228542A1.pdf](http://hraunfoss.fcc.gov/edocs_public/attachmatch/DOC-228542A1.pdf)

- [16] J.H. Snider “The Rhetoric and Reality of Progress in Allocating More Spectrum for Unlicensed Use” New America Foundation Whitepaper, February 2006, Website: [http://www.newamerica.net/files/archive/Doc\\_File\\_2897\\_1.pdf](http://www.newamerica.net/files/archive/Doc_File_2897_1.pdf)
- [17] C. Jackson, “Dynamic Sharing of Radio Spectrum: A Brief History”, in Proceedings of the 1st IEEE International Symposium on New Frontiers in Dynamic Spectrum Access Networks (DySpan 2005), Baltimore, MD,USA, pp. 445–466, Nov. 2005.
- [18] D. DePardo, “Adjacent Channel TV Band Device Test”, ITTC Report on DTV Co-Channel Interference, April 2, 2007.
- [19] Federal Communications Commission, “Unlicensed operation in the TV broadcast bands.” ET Docket No. 04-113, May 2004.
- [20] BBN Technologies, “The XG Vision: Request for Comments”, Technical Report, version 2.0.
- [21] T. Hearn, “Bush Signs Bill Ending Analog TV”, Multichannel News, February 8, 2006. Website: <http://www.multichannel.com/index.asp?layout=articlePrint&articleID=CA6305856>
- [22] M. Calabrese, “Measuring TV 'White Space' Available for Unlicensed Wireless Broadband”, New America Foundation and Free Press Analysis, January 2006. Website: [http://www.newamerica.net/files/archive/Doc\\_File\\_2713\\_1.pdf](http://www.newamerica.net/files/archive/Doc_File_2713_1.pdf)
- [23] C. Cordeiro, K. Challapali, D. Birru, and S. Shankar, “IEEE 802.22: The first worldwide wireless standard based on cognitive radios in Proceedings of the 1st IEEE International Symposium on New Frontiers in Dynamic Spectrum Access Networks (DySpan 2005), Baltimore, MD,USA, pp. 328–337. November 2005.
- [24] A. E. Leu, K. Steadman, M. McHenry, and J. Bates, “Ultra sensitive TV detector measurements,” in Proceedings of the 1st IEEE International Symposium on New Frontiers in Dynamic Spectrum Access Networks (DySpan 2005), Baltimore, MD,USA, pp. 30–36. November 2005.
- [25] E. Visotsky, S. Kuffner, and R. Peterson, “On collaborative detection of TV transmissions in support of dynamic spectrum sharing,” in Proceedings of the 1st IEEE International Symposium on New Frontiers in Dynamic Spectrum Access Networks (DySpan 2005), Baltimore, MD,USA, pp. 338–343. November 2005.
- [26] B. Wild and K. Ramchandran, “Detecting Primary Receivers for Cognitive Radio Applications,” in the Proceedings of the 1<sup>st</sup> IEEE International Symposium on New Frontiers in Dynamic Spectrum Access Networks, (Baltimore, MD,USA), pp. 124–130, November 2005.
- [27] M. McHenry, “The Probe Spectrum Access Method,” in the Proceedings of the 1<sup>st</sup> IEEE International Symposium on New Frontiers in Dynamic Spectrum Access Networks (DySPAN 2005), Baltimore, MD,USA, pp. 346–351, Nov. 2005.
- [28] Federal Communications Commission Spectrum Policy Task Force, “Report of the Spectrum Efficiency Working Group”, November 15, 2002. Website: [http://www.fcc.gov/sptf/files/SEWGFinalReport\\_1.pdf](http://www.fcc.gov/sptf/files/SEWGFinalReport_1.pdf)
- [29] NTIA Institute for Telecommunications Sciences, “Radio Spectrum Measurement System (RSMS) Program”. Website: <http://glossary.its.blrdoc.gov/programs/rsms/index.php>
- [30] P. Raush, J. Kub, E. Gray, “Automatic Radio Frequency Monitoring Measurements”, In the Proceedings of the 1999 IEEE International Symposium on Electromagnetic Compatibility, Volume 2, pp. 716-721, August 2, 1999. Website: <http://ieeexplore.ieee.org/iel5/6560/17532/00810106.pdf>

- [31] NTIA Report TR-98-357, "Land Mobile Channel Usage Measurements at the 1996 Summer Olympic Games", February 1998. Website:  
<http://glossary.its.blrdoc.gov/pub/ntia-rpt/98-357/>
- [32] Ofcom AIMS Programme, "Autonomous Interference Monitoring System – Phase 2", March 2007. Website:  
[http://www.ofcom.org.uk/research/technology/overview/state\\_use/aims2/aims2\\_1.pdf](http://www.ofcom.org.uk/research/technology/overview/state_use/aims2/aims2_1.pdf)
- [33] M. A. McHenry, S. Chunduri, "Spectrum Occupancy Measurements, Location 3 of 6: National Science Foundation Building Roof, April 16, 2004, Revision 2", Shared Spectrum Company, April 16, 2004. Website:  
[http://www.sharespectrum.com/inc/content/measurements/nsf/3\\_NSF\\_Building\\_Roof\\_Report.pdf](http://www.sharespectrum.com/inc/content/measurements/nsf/3_NSF_Building_Roof_Report.pdf)
- [34] M. A. McHenry, D. McCloskey, "Spectrum Occupancy Measurements, Location 4 of 6: Republican National Convention, New York City, New York, August 30, 2004 - September 3, 2004, Revision 2", Shared Spectrum Company, September, 3, 2004. Website:  
[http://www.sharespectrum.com/inc/content/measurements/nsf/4\\_NSF\\_NYC\\_Report.pdf](http://www.sharespectrum.com/inc/content/measurements/nsf/4_NSF_NYC_Report.pdf)
- [35] A. J. Petrin, "Maximizing the Utility of Radio Spectrum: Broadband Spectrum Measurements and Occupancy Model for Use By Cognitive Radio" Ph.D. Thesis, August 2005. Website:  
[http://smartech.gatech.edu/dspace/bitstream/1853/11648/1/petrin\\_allen\\_j\\_200508\\_phd.pdf](http://smartech.gatech.edu/dspace/bitstream/1853/11648/1/petrin_allen_j_200508_phd.pdf)
- [36] W.R. Vincent, R.W. Adler, A.A. Parker, "Signal Population in the License-Exempt Wireless-Radio Bands at the MOUT site", Naval Postgraduate School Report, October 2004. Website: <http://bosun.nps.edu/uhtbin/hyperion.exe/NPS-EC-05-001.pdf>
- [37] W.R. Vincent, R.W. Adler, A.A. Parker, G.F. Munsch, "An Initial Examination of the Occupancy and Use of the Wireless-Radio Bands" Naval Postgraduate School Report, September 2006.
- [38] W.R. Vincent, R.W. Adler, A.A. Parker, G.F. Munsch, "The Mitigation of Radio Noise from External Sources at Radio Receiving Sites", Naval Postgraduate School Report, May 2007.
- [39] T.M. Taher, M.J. Misurac, J.L. LoCicero, D.R. Ucci, "Microwave Oven Signal Interference and Mitigation for Wi-Fi Communications Systems", submitted to Military Communications Conference (MILCOM) 2007. Website:  
<http://www.ece.iit.edu/~taher/pub4.pdf>
- [40] FCC Spectrum Efficiency Working Group, "Report of the Spectrum Efficiency Working Group", November 15, 2002. Website:  
[http://www.fcc.gov/sptf/files/SEWGFinalReport\\_1.pdf](http://www.fcc.gov/sptf/files/SEWGFinalReport_1.pdf)
- [41] M.A. McHenry, D.A. Roberson, "Chicago Spectrum Occupancy Measurements & Analysis and a Long-term Studies Proposal" In the Proceedings of the TAPAS'06 First International Workshop on Technology and Policy for Accessing Spectrum, August 5, 2006, Boston, MA, United States. Website:  
<http://portal.acm.org/citation.cfm?id=1234388.1234389>
- [42] S. Shankar, C. Cordeiro, K. Challapali, "Spectrum Agile Radios: Utilization and Sensing Architectures" in the Proceedings of the 1<sup>st</sup> IEEE International Symposium on New Frontiers in Dynamic Spectrum Access Networks (DySPAN 2005), Baltimore, MD, USA, November 2005.

- [43] NSF GENI: Global Environment for Network Innovations Program, "Technical Document on Overview – Wireless, Mobile and Sensor Networks", GDD-06-14, p. 29, September 15, 2006. Website: <http://www.geni.net/GDD/GDD-06-14.pdf>
- [44] D. Cabric, S. Mubaraq, R. Brodersen, "Implementation Issues in Spectrum Sensing for Cognitive Radios" Asilomar Conference on Signals, Systems and Computers, 2004. Website: <http://bwrc.eecs.berkeley.edu/Publications/2004/PRESENTATIONS/dc.smm.asilomar/index.htm>
- [45] N. Shah, T. Kamakaris, U. Tureli, M. Buddhikot, "Wideband Spectrum Probe for Distributed Measurements in Cellular Band", In the Proceedings of the TAPAS'06 First International Workshop on Technology and Policy for Accessing Spectrum, August 5, 2006, Boston, MA, United States. Website: <http://portal.acm.org/citation.cfm?id=1234388.1234401>
- [46] A.E.E. Rogers, J.E. Salah, D.L. Smythe, P.Pratap, J.C. Carter, M. Derome, "Interference temperature measurements from 70 to 1500 MHz in suburban and rural environments of the Northeast" in the Proceedings of the 1<sup>st</sup> IEEE International Symposium on New Frontiers in Dynamic Spectrum Access Networks (DySPAN 2005), Baltimore, MD, USA,
- [47] P. J. Kolodzy, "Interference temperature: a metric for dynamic spectrum utilization," Wiley International Journal of Network Management, Vol. 16, pp. 103-113, 2006.
- [48] T.C. Clancy, "Formalizing the Interference Temperature Model," Wiley Wireless Communications and Mobile Computing 2006. Website: <http://www.cs.umd.edu/~clancy/docs/itma-wcmc06.pdf>
- [49] Federal Register, "Federal Communications Commission – 47 CFR Part 15 – ET Docket No. 03-237; FCC 07-78 - Interference Temperature Operation", Vol. 72, No. 103. Wednesday, May 30, 2007.
- [50] D. Datla, "Spectrum Surveying for Dynamic Spectrum Access Networks", M.S. Thesis, University of Kansas, January 2007.
- [51] C. Dietrich, "Adaptive Arrays and Diversity Antenna Configurations for Handheld Wireless Communication Terminals", Ph.D Dissertation, Virginia Tech University, February 15, 2000. Website: <http://scholar.lib.vt.edu/theses/available/etd-04262000-15330030/unrestricted/etd.pdf>
- [52] R. Tandra, "Fundamental limits on detection in low SNR", M.S. Thesis, University of California, Berkeley, Sprint 2005. Website: [http://www.eecs.berkeley.edu/~sahai/Theses/Rahul\\_MSThesis.pdf](http://www.eecs.berkeley.edu/~sahai/Theses/Rahul_MSThesis.pdf)
- [53] D.A.Roberson, C.S.Hood, J.L.LoCicero, J.T.MacDonald, "Spectral Occupancy and Interference Studies in Support of Cognitive Radio Technology Deployment", IEEE Workshop on Networking Technologies for SDR, San Diego, CA, October 2006. Website: [http://www.wemi.ece.iit.edu/publications/Cognitive%20Radio%20WoOrkshop%20\\_v8.2\\_.pdf](http://www.wemi.ece.iit.edu/publications/Cognitive%20Radio%20WoOrkshop%20_v8.2_.pdf). Weidling, "DB Specification", KUAR documentation, University of Kansas, 2003.
- [54] J. Mitola, "The Software Radio Architecture", IEEE Communications Magazine, 1995.
- [55] J. Mitola, "Cognitive radio: An integrated agent architecture for software" KTH Ph.D. Dissertation, 2000.
- [56] J. Mitola, "Cognitive Radio for Flexible Mobile Multimedia Communications," in Proceedings of the IEEE International Workshop of Mobile Multimedia Communications, vol. 1, (San Diego, CA, USA), pp. 3–10, November 1999.



- [57] B.A. Barker, "An Expert System Approach to Defining Initial Configurations for Software-Defined Radios", M.S. Thesis, University of Kansas, April 2007.
- [58] D. Maldonado, B. Le, A. Hugine, T.W. Rondeau, and C.W. Bostian, "Cognitive radio applications to dynamic spectrum allocation," in the Proceedings of the IEEE International Symposium on New Frontiers in Dynamic Spectrum Access Networks (DySPAN 2005), Baltimore, MD, USA, pp. 597-600, November 2005
- [59] A. Ginsberg, J.D. Poston, W.D. Horne, "Experiments in Cognitive Radio and Dynamic Spectrum Access using An Ontology-Rule Hybrid Architecture", Second International RuleML-2006 Conference, 2006.
- [60] O. Ileri, D. Samardzija, T. Sizer, N. Mandayam, "Demand responsive pricing and competitive spectrum allocation via a spectrum server" in the Proceedings of the IEEE International Symposium on New Frontiers in Dynamic Spectrum Access Networks (DySPAN 2005), Baltimore, MD, USA, November 2005.
- [61] O. Simeone, Y. Bar-Ness, "A game-theoretic view on the interference channel with random access" in the Proceedings of the 2nd IEEE International Symposium on New Frontiers in Dynamic Spectrum Access Networks (DySPAN 2007), Dublin, IE, April 2007.
- [62] N. Nie, C. Comaniciu, "Adaptive channel allocation spectrum etiquette for cognitive radio networks", in the Proceedings of the IEEE International Symposium on New Frontiers in Dynamic Spectrum Access Networks (DySPAN 2005), Baltimore, MD, USA, November 2005.
- [63] G. J. Minden, J. B. Evans, L. Searl, D. DePardo, V. R. Petty, R. Rajbanshi, T. Newman, Q. Chen, F. Weidling, J. Guffey, D. Datla, B. Barker, M. Peck, B. Cordill, A. M. Wyglinski and A. Agah, "KUAR: A Flexible Software-Defined Radio Development Platform" in Proceedings of the 2nd IEEE International Symposium on New Frontiers in Dynamic Spectrum Access Networks (DySpan 2007), (Dublin, Ireland), April 2007.
- [64] Hewlett-Packard 8590 series spectrum analyzer user's manual, July 1998. Website: [http://www.home.agilent.com/agilent/redirector.jsp?action=ref&cname=AGILENT\\_EDITORIAL&ckey=100000079-1%3Aeapsg%3Aaman&lc=eng&cc=US](http://www.home.agilent.com/agilent/redirector.jsp?action=ref&cname=AGILENT_EDITORIAL&ckey=100000079-1%3Aeapsg%3Aaman&lc=eng&cc=US)
- [65] Hewlett-Packard 8590 series Programmer's guide, June 1995. Website: [http://www.home.agilent.com/agilent/redirector.jsp?action=ref&cname=AGILENT\\_EDITORIAL&ckey=100000077-1%3Aeapsg%3Aaman&lc=eng&cc=US](http://www.home.agilent.com/agilent/redirector.jsp?action=ref&cname=AGILENT_EDITORIAL&ckey=100000077-1%3Aeapsg%3Aaman&lc=eng&cc=US)
- [66] FCC Audio Division, FMQ FM Radio Database Query website. Website: <http://www.fcc.gov/mb/audio/fmq.html>
- [67] Times Microwave LMR-600 cable datasheet. Website: <http://www.timesmicrowave.com/telecom/pdf/28-31.pdf>
- [68] S.O. Rice, "Mathematical Analysis of Random Noise," Bell Systems Technology Journal, vol. 24, pp. 46-156, 1945
- [69] M. Pagano, K. Gauvreau, Principles of Biostatistics, 2000.
- [70] National Association of Broadcasters and Maximum Service Television, "Comment on FCC Docket No. 04-186", FCC Website, November 30, 2004. Website: [http://gullfoss2.fcc.gov/prod/ecfs/retrieve.cgi?native\\_or\\_pdf=pdf&id\\_document=6516883656](http://gullfoss2.fcc.gov/prod/ecfs/retrieve.cgi?native_or_pdf=pdf&id_document=6516883656)
- [71] American Federation of Musicians, "Comment on FCC Docket No. 04-186", October 2006.
- [72] A. Leu, K. Steadman, M. McHenry, J. Bates "Ultra Sensitive TV Detector Measurements" in the Proceedings of the IEEE International Symposium on New

- Frontiers in Dynamic Spectrum Access Networks (DySPAN 2005), Baltimore, MD, USA, November 2005, pp. 30-36
- [73] D. DePardo, J. B. Evans, J. A. Roberts, V. R. Petty, A. M. Wyglinski, P. J. Kolodzy, M. J. Marcus, "Quantifying the Impact of Unlicensed Devices on Digital TV Receivers" FCC comment on Docket 04-186, January 2007. Website:  
[http://gullfoss2.fcc.gov/prod/ecfs/retrieve.cgi?native\\_or\\_pdf=pdf&id\\_document=6518724364](http://gullfoss2.fcc.gov/prod/ecfs/retrieve.cgi?native_or_pdf=pdf&id_document=6518724364)
- [74] M. J. Marcus, P. Kolodzy, A. Lippman, „“Why Unlicensed Use of Vacant TV Spectrum Will Not Interfere with Television Reception“, New America Foundation Issue Brief, July 2006. Website:  
[http://www.newamerica.net/files/IssueBrief19.UnlicensedTVBand.MarcusKolodzyLippman.Final\\_.pdf](http://www.newamerica.net/files/IssueBrief19.UnlicensedTVBand.MarcusKolodzyLippman.Final_.pdf)
- [75] Wireless Internet Service Provider’s Association, “Comments in response to ET docket no. 04-186,” March 2006.
- [76] C. W. Rhodes, “Interference between television signals due to inter-modulation in receiver front - ends,” IEEE Transactions on Broadcasting, vol. 51, pp. 31–37, March 2005.
- [77] V. R. Petty, R. Rajbanshi, D. Datla, F. Weidling, D. DePardo, P. J. Kolodzy, M. J. Marcus, A. M. Wyglinski, J. B. Evans, G. J. Minden, J. A. Roberts, "Feasibility of Dynamic Spectrum Access in Underutilized Television Bands" in Proceedings of the 2nd IEEE International Symposium on New Frontiers in Dynamic Spectrum Access Networks (DySpan 2007), (Dublin, Ireland), April 2007.

## Appendix A – Matlab workspace import

Example Matlab code that is generated by the Spectrum Miner program to import a measurement directly into the Matlab workspace:

```
mysql('open', 'localhost', 'root', '');
mysql('use spectrum');
[ start_time, stop_time, sweep_inst_id, frequ_index, amp,
start_freq, stop_freq, freq_step, analyzer_settings_id ] =
mysql('SELECT `sweep-
1652c6e3513172e382b4f116a3d233bf`.`start_time`, `sweep-
1652c6e3513172e382b4f116a3d233bf`.`stop_time`, `measurement-
1652c6e3513172e382b4f116a3d233bf`.*,
analyzer_settings.`start_freq`, analyzer_settings.`stop_freq`,
analyzer_settings.`freq_step`,
analyzer_settings.`analyzer_settings_id` FROM `sweep-
1652c6e3513172e382b4f116a3d233bf`, `measurement-
1652c6e3513172e382b4f116a3d233bf`, analyzer_settings WHERE
`sweep-
1652c6e3513172e382b4f116a3d233bf`.`sweep_instance_id`=`measure-
ment-1652c6e3513172e382b4f116a3d233bf`.`sweep_instance_id` AND
`sweep-
1652c6e3513172e382b4f116a3d233bf`.`analyzer_settings_id`=analy-
zer_settings.`analyzer_settings_id`');
mysql('close');
fstep = sscanf(char(freq_step), 'LINEAR=%f');
```

## Appendix B – KUAR spectrum measurement calibration

The following plots show the relative power values measured by the KUAR, the KUAR power values converted to dB and the KUAR measured power with a correction factor. These plots represent power measurements for signal generator output values of -20, -15, -10, -5 and 0 dBm.

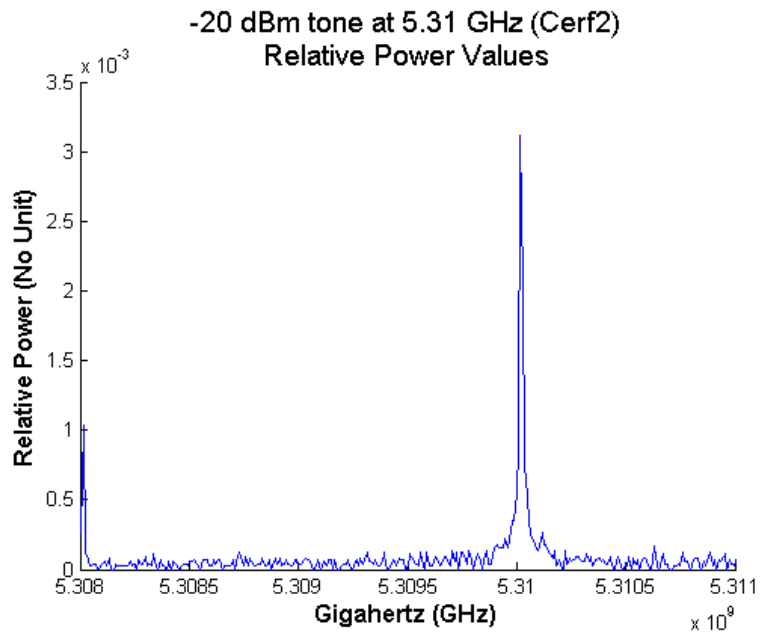

**Figure 51 – KUAR measured relative power values for a -20 dBm tone at 5.31 GHz transmitted over the air in the laboratory**

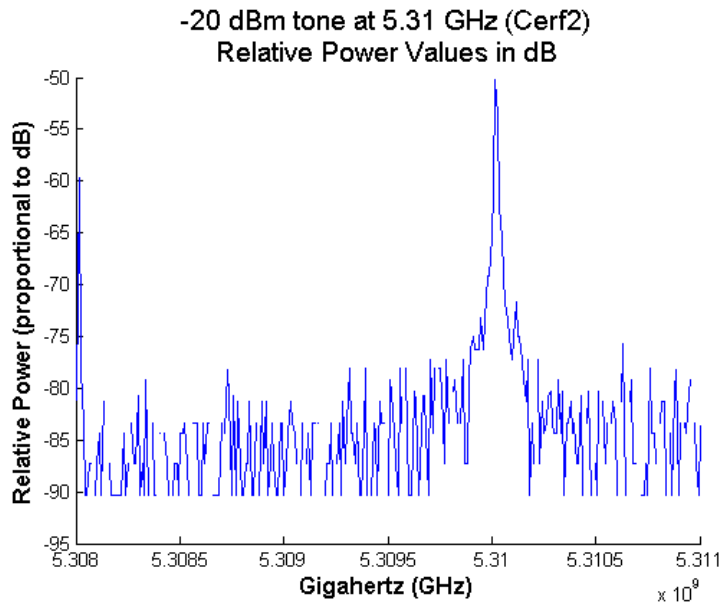

Figure 52 – KUAR measured power in dB for a -20 dBm tone at 5.31 GHz transmitted over the air in the laboratory

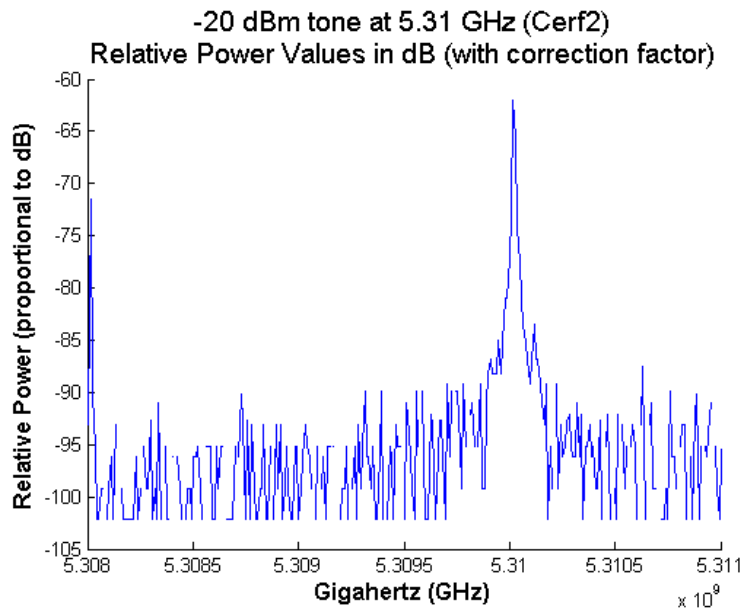

Figure 53 – KUAR measured power values with a correction factor for a -20 dBm tone at 5.31 GHz transmitted over the air in the laboratory

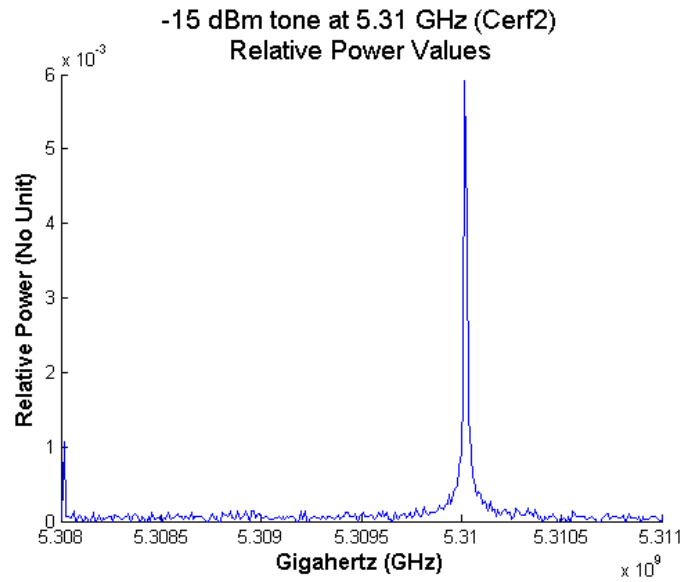

Figure 54 - KUAR measured relative power values for a -15 dBm tone at 5.31 GHz transmitted over the air in the laboratory

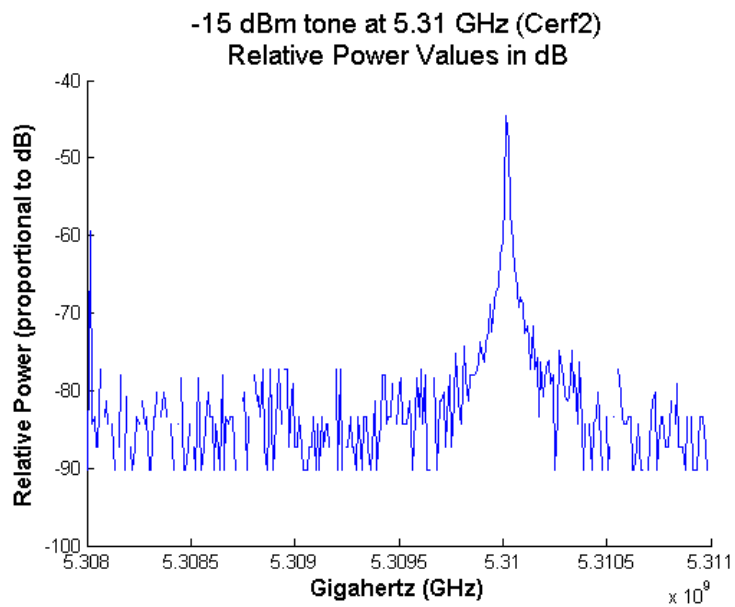

Figure 55 - KUAR measured power in dB for a -15 dBm tone at 5.31 GHz transmitted over the air in the laboratory

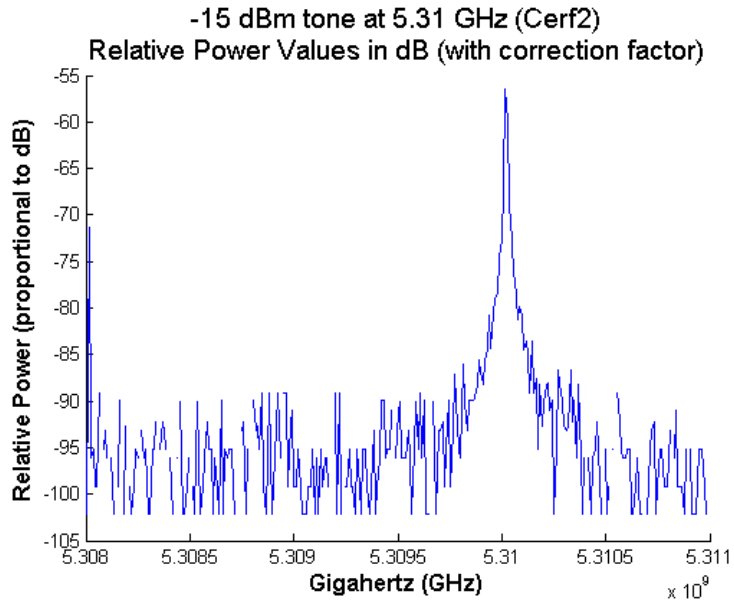

Figure 56 - KUAR measured power values with a correction factor for a -15 dBm tone at 5.31 GHz transmitted over the air in the laboratory

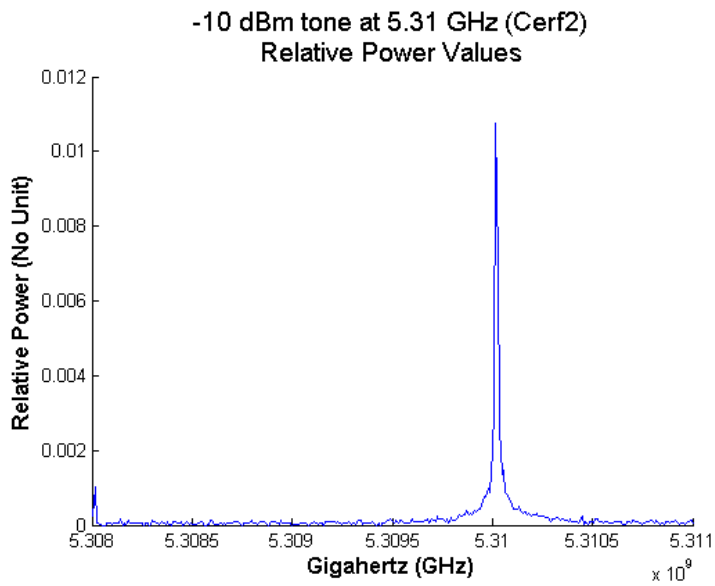
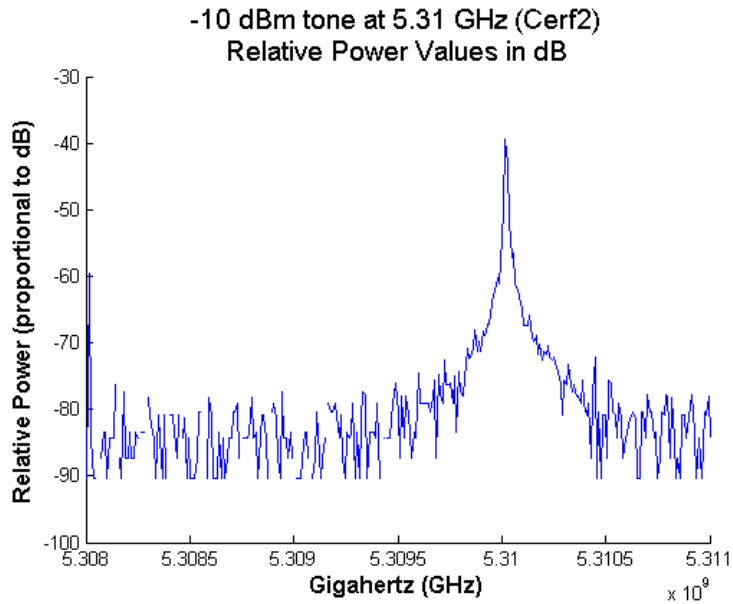
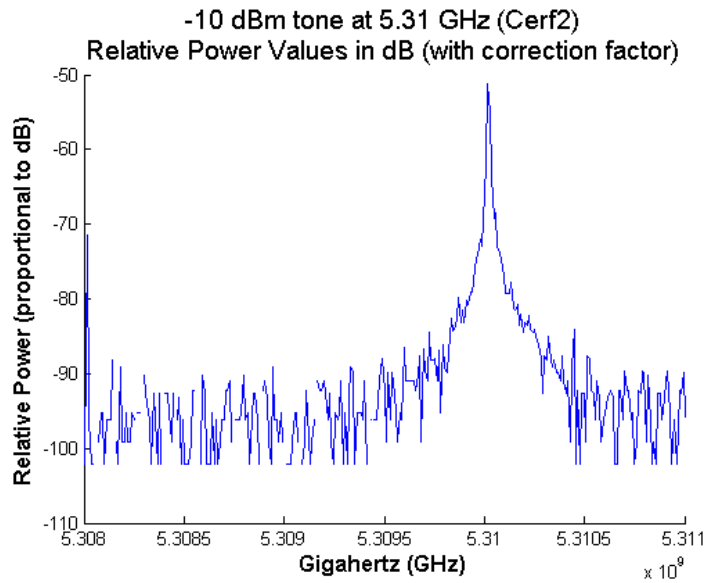

Figure 57 - KUAR measured relative power values for a -10 dBm tone at 5.31 GHz transmitted over the air in the laboratory

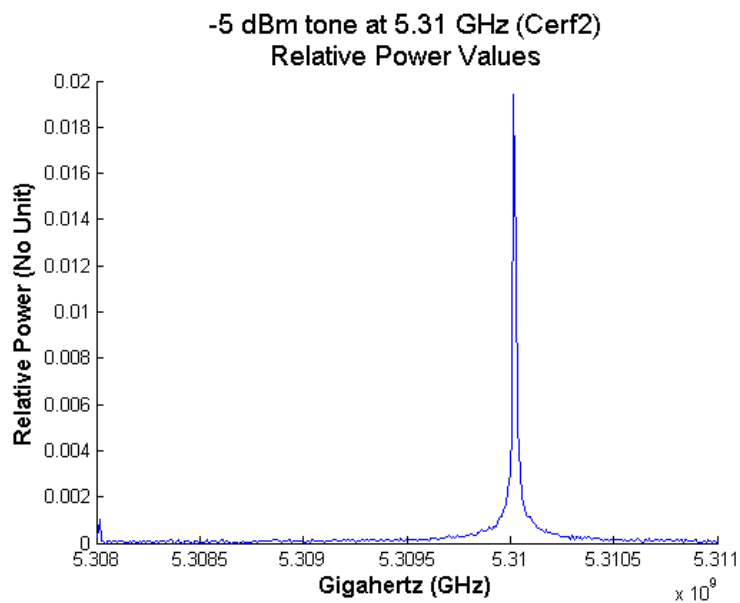

**Figure 58 - KUAR measured power in dB for a -20 dBm tone at 5.31 GHz transmitted over the air in the laboratory**

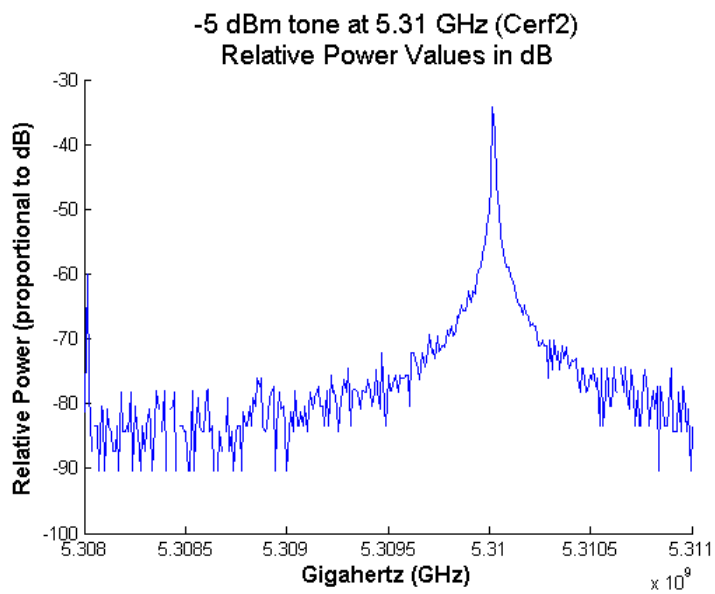

**Figure 59 - KUAR measured power values with a correction factor for a -10 dBm tone at 5.31 GHz transmitted over the air in the laboratory**

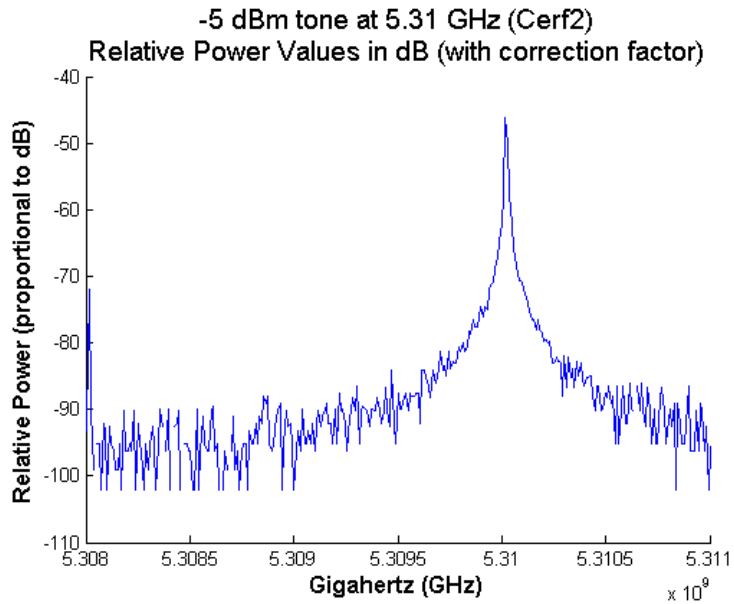



**Figure B10 - KUAR measured relative power values for a -5 dBm tone at 5.31 GHz transmitted over the air in the laboratory**



**Figure B11 - KUAR measured power in dB for a -20 dBm tone at 5.31 GHz transmitted over the air in the laboratory**



**Figure B12 - KUAR measured power values with a correction factor for a -5 dBm tone at 5.31 GHz transmitted over the air in the laboratory**

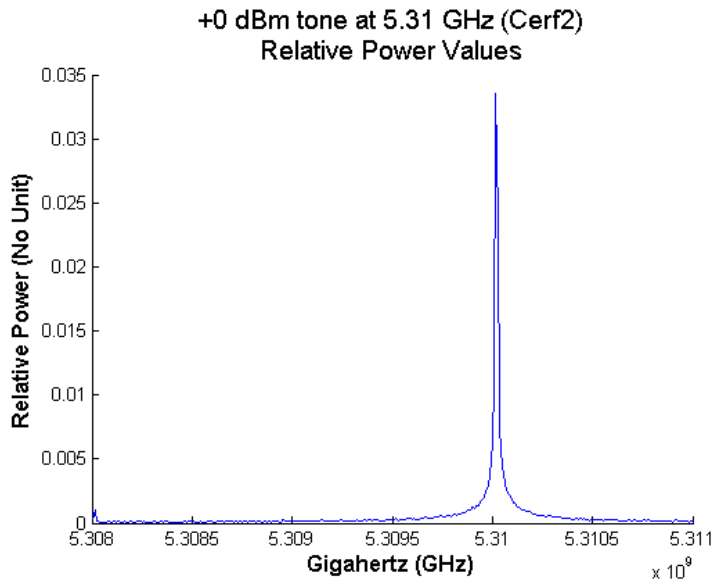

**Figure B13 - KUAR measured relative power values for a +0 dBm tone at 5.31 GHz transmitted over the air in the laboratory**

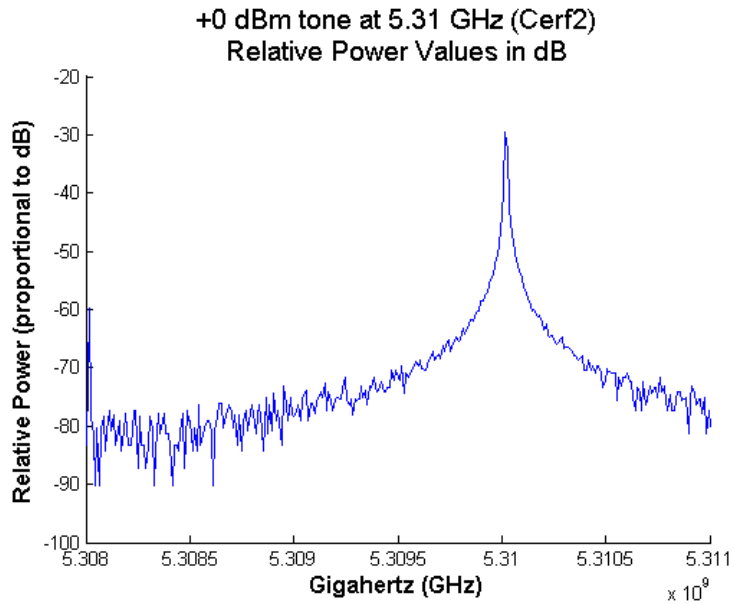

**Figure B14 - KUAR measured power in dB for a +0 dBm tone at 5.31 GHz transmitted over the air in the laboratory**

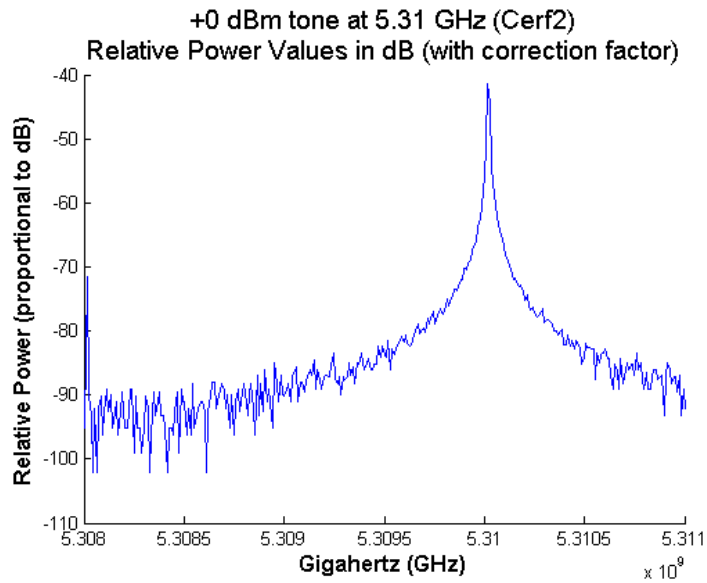

**Figure B15 - KUAR measured power values with a correction factor for a +0 dBm tone at 5.31 GHz transmitted over the air in the laboratory**